



# Acoustic Leak Detector HIKMICRO AD Series

## User Manual



Contact Us

## Legal Information

©2023 Hangzhou Microimage Software Co., Ltd. All rights reserved.

### About this Manual

The Manual includes instructions for using and managing the Product. Pictures, charts, images and all other information hereinafter are for description and explanation only. The information contained in the Manual is subject to change, without notice, due to firmware updates or other reasons. Please find the latest version of this Manual at the HIKMICRO website (<http://www.hikmicrotech.com>).

Please use this Manual with the guidance and assistance of professionals trained in supporting the Product.

### Trademarks

 **HIKMICRO** and other HIKMICRO's trademarks and logos are the properties of HIKMICRO in various jurisdictions. Other trademarks and logos mentioned are the properties of their respective owners.

### DISCLAIMER

TO THE MAXIMUM EXTENT PERMITTED BY APPLICABLE LAW, THIS MANUAL AND THE PRODUCT DESCRIBED, WITH ITS HARDWARE, SOFTWARE AND FIRMWARE, ARE PROVIDED "AS IS" AND "WITH ALL FAULTS AND ERRORS". HIKMICRO MAKES NO WARRANTIES, EXPRESS OR IMPLIED, INCLUDING WITHOUT LIMITATION, MERCHANTABILITY, SATISFACTORY QUALITY, OR FITNESS FOR A PARTICULAR PURPOSE. THE USE OF THE PRODUCT BY YOU IS AT YOUR OWN RISK. IN NO EVENT WILL

HIKMICRO BE LIABLE TO YOU FOR ANY SPECIAL, CONSEQUENTIAL, INCIDENTAL, OR INDIRECT DAMAGES, INCLUDING, AMONG OTHERS, DAMAGES FOR LOSS OF BUSINESS PROFITS, BUSINESS INTERRUPTION, OR LOSS OF DATA, CORRUPTION OF SYSTEMS, OR LOSS OF DOCUMENTATION, WHETHER BASED ON BREACH OF CONTRACT, TORT (INCLUDING NEGLIGENCE), PRODUCT LIABILITY, OR OTHERWISE, IN CONNECTION WITH THE USE OF THE PRODUCT, EVEN IF HIKMICRO HAS BEEN ADVISED OF THE POSSIBILITY OF SUCH DAMAGES OR LOSS.

YOU ACKNOWLEDGE THAT THE NATURE OF THE INTERNET PROVIDES FOR INHERENT SECURITY RISKS, AND HIKMICRO SHALL NOT TAKE ANY RESPONSIBILITIES FOR ABNORMAL OPERATION, PRIVACY LEAKAGE OR OTHER DAMAGES RESULTING FROM CYBER-ATTACK, HACKER ATTACK, VIRUS INFECTION, OR OTHER INTERNET SECURITY RISKS; HOWEVER, HIKMICRO WILL PROVIDE TIMELY TECHNICAL SUPPORT IF REQUIRED.

YOU AGREE TO USE THIS PRODUCT IN COMPLIANCE WITH ALL APPLICABLE LAWS, AND YOU ARE SOLELY RESPONSIBLE FOR ENSURING THAT YOUR USE CONFORMS TO THE APPLICABLE LAW. ESPECIALLY, YOU ARE RESPONSIBLE, FOR USING THIS PRODUCT IN A MANNER THAT DOES NOT INFRINGE ON THE RIGHTS OF THIRD PARTIES, INCLUDING WITHOUT LIMITATION, RIGHTS OF PUBLICITY, INTELLECTUAL PROPERTY RIGHTS, OR DATA PROTECTION AND OTHER PRIVACY RIGHTS. YOU SHALL NOT USE THIS PRODUCT FOR ANY PROHIBITED END-USES, INCLUDING THE DEVELOPMENT OR PRODUCTION OF WEAPONS OF MASS DESTRUCTION, THE DEVELOPMENT OR PRODUCTION OF CHEMICAL OR BIOLOGICAL WEAPONS, ANY ACTIVITIES IN THE CONTEXT RELATED TO ANY NUCLEAR EXPLOSIVE OR UNSAFE

NUCLEAR FUEL-CYCLE, OR IN SUPPORT OF HUMAN RIGHTS ABUSES.

IN THE EVENT OF ANY CONFLICTS BETWEEN THIS MANUAL AND THE APPLICABLE LAW, THE LATTER PREVAILS.

## Regulatory Information

---

**These clauses apply only to the products bearing the corresponding mark or information.**

---

### EU Compliance Statement

 This product and - if applicable - the supplied accessories too are marked with "CE" and comply therefore with the applicable harmonized European standards listed under the Directive 2014/30/EU (EMCD) and Directive 2011/65/EU (RoHS).

Note: The products with the input voltage of within 50 to 1000 VAC or 75 to 1500 VDC comply with Directive 2014/35/EU (LVD), and the rest products comply with Directive 2001/95/EC (GPSD). Please check the specific power supply information for reference.

For the device without a supplied power adapter, use the power adapter provided by a qualified manufacturer. Refer to the product specification for detailed power requirements.

For the device without a supplied battery, use the battery provided by a qualified manufacturer. Refer to the product specification for detailed battery requirements.



Directive 2012/19/EU (WEEE Directive): Products marked with this symbol cannot be disposed of as unsorted municipal waste in the European Union. For proper recycling, return this product to your local supplier upon the purchase of equivalent new equipment, or dispose of it at designated collection points. For more information see: [www.recyclethis.info](http://www.recyclethis.info).



Directive 2006/66/EC and its amendment 2013/56/EU (Battery Directive): This product contains a battery that cannot be disposed of as unsorted municipal waste in the European Union. See the product documentation for specific battery information. The battery is marked with this symbol, which may include lettering to indicate cadmium (Cd), lead (Pb), or mercury (Hg). For proper recycling, return the battery to your supplier or to a designated collection point. For more information see: [www.recyclethis.info](http://www.recyclethis.info).

According to the Batteries and Accumulators (Placing on the Market) Regulations 2008 and the Waste Batteries and Accumulators Regulations 2009: This product contains a battery that cannot be disposed of as unsorted municipal waste in the United Kingdom. See the product documentation for specific battery information. The battery is marked with this symbol, which may include lettering to indicate cadmium (Cd), lead (Pb), or mercury (Hg). For proper recycling, return the battery to your supplier or to a designated collection point. For more information see: [www.recyclethis.info](http://www.recyclethis.info).

### **Industry Canada ICES-003 Compliance**

This device meets the CAN ICES-003 (B)/NMB-003 (B) standards requirements.



Cet appareil répond aux exigences des normes CAN ICES-003 (B)/NMB-003 (B).

### **KC**

B급 기기: 이 기기는 가정용(B급) 전자파적합기기로서 주로 가정에서 사용하는 것을 목적으로 하며, 모든 지역에서 사용할 수 있습니다.

## Symbol Conventions

The symbols that may be found in this document are defined as follows.

Symbol	Description
 <b>Danger</b>	Indicates a hazardous situation which, if not avoided, will or could result in death or serious injury.
 <b>Caution</b>	Indicates a potentially hazardous situation which, if not avoided, could result in equipment damage, data loss, performance degradation, or unexpected results.
 <b>Note</b>	Provides additional information to emphasize or supplement important points of the main text.

## **Safety Instruction**

These instructions are intended to ensure that user can use the product correctly to avoid danger or property loss. Please read all the safety information carefully before using.

### **Laws and Regulations**

Use of the product must be in strict compliance with the local electrical safety regulations.

### **Transportation**

- Keep the device in original or similar packaging while transporting it.
- Keep all wrappers after unpacking them for future use. In case of any failure occurred, you need to return the device to the factory with the original wrapper.
- Transportation without the original wrapper may result in damage on the device and the company shall not take any responsibilities.
- DO NOT drop the product or subject it to physical shock. Keep the device away from magnetic interference.

### **Power Supply**

- Input voltage for the device should meet the Limited Power Source (12 VDC, 1.5 A) according to the IEC62368 standard. Please refer to technical specifications for detailed information.
- Make sure the plug is properly connected to the power socket.
- DO NOT connect multiple devices to one power adapter, to avoid over-heating or fire hazards caused by overload.

### **Battery**

- Improper use or replacement of the battery may result in



explosion hazard. Replace with the same or equivalent type only. Dispose of used batteries in conformance with the instructions provided by the battery manufacturer.

- The built-in battery cannot be dismantled. Please contact the manufacture for repair if necessary.
- For long-term storage of the battery, make sure it is fully charged every half year to ensure the battery quality. Otherwise, damage may occur.
- When the device is powered off and the RTC battery is full, the time settings can be kept for 6 months.
- In the first use, charge the device for more than 6 hours in the power-off status.
- The lithium battery voltage is 3.6 V, and the battery capacity is 10050 mAh.

## **Maintenance**

- If the product does not work properly, please contact your dealer or the nearest service center. We shall not assume any responsibility for problems caused by unauthorized repair or maintenance.
- A few device components (e.g., electrolytic capacitor) require regular replacement. The average lifespan varies, so periodic checking is recommended. Contact your dealer for details.
- Wipe the device gently with a clean cloth and a small quantity of ethanol, if necessary.
- If the equipment is used in a manner not specified by the manufacturer, the protection provided by the device may be impaired.
- Please notice that the current limit of USB 3.0 PowerShare port may vary with the PC brand, which is likely to result in

incompatibility issue. Therefore, it's advised to use regular USB 3.0 or USB 2.0 port if the USB device fails to be recognized by PC via USB 3.0 PowerShare port.

## Using Environment

- Make sure the running environment meets the requirement of the device. The operating temperature shall be -10 °C to 50 °C (14 °F to 122 °F), and the operating humidity shall be 95% or less.
- Place the device in a dry and well-ventilated environment.
- DO NOT expose the device to high electromagnetic radiation or dusty environments.
- DO NOT expose the device in wet conditions.
- The level of protection of the device is as follows: Main Unit: IP40; Handheld sensor: IP54; Pick-up sensor: IP66.
- The pollution degree is 2.

## Technical Support

The <https://www.hikmicrotech.com/en/contact-us.html> portal will help you as a HIKMICRO customer to get the most out of your HIKMICRO products. The portal gives you access to our support team, software and documentation, service contacts, etc.

## Emergency

If smoke, odor, or noise arises from the device, immediately turn off the power, unplug the power cable, and contact the service center.

## Manufacture Address

Room 313, Unit B, Building 2, 399 Danfeng Road, Xixing  
Subdistrict, Binjiang District, Hangzhou, Zhejiang 310052, China  
Hangzhou Microimage Software Co., Ltd.

# Contents

<b>Chapter 1 Overview .....</b>	<b>1</b>
<b>1.1 Device Description .....</b>	<b>1</b>
<b>1.2 Main Function .....</b>	<b>1</b>
<b>1.3 Appearance .....</b>	<b>2</b>
<b>Chapter 2 Preparation.....</b>	<b>4</b>
<b>2.1 Assemble Accessories .....</b>	<b>4</b>
<b>2.1.1 Mount the Neck Strap .....</b>	<b>4</b>
<b>2.1.2 Mount the Handheld Sensor.....</b>	<b>4</b>
<b>2.1.3 Mount the Pick-up Sensor .....</b>	<b>5</b>
<b>2.2 Power On/Off .....</b>	<b>5</b>
<b>2.2.1 Set Auto Power-off Duration .....</b>	<b>6</b>
<b>2.3 Set Auto Sleep .....</b>	<b>6</b>
<b>2.4 Swipe-Down Menu .....</b>	<b>6</b>
<b>Chapter 3 Display Settings .....</b>	<b>7</b>
<b>3.1 Display Appearance .....</b>	<b>7</b>
<b>3.2 Set Screen Brightness .....</b>	<b>7</b>
<b>3.3 Display OSD Info.....</b>	<b>8</b>
<b>Chapter 4 Leakage Sites Inspection .....</b>	<b>9</b>
<b>4.1 Quick Inspection.....</b>	<b>9</b>
<b>4.2 Route Inspection .....</b>	<b>11</b>
<b>4.2.1 Collect Possible Leakage Sites.....</b>	<b>11</b>
<b>4.2.2 Analyze Site Data .....</b>	<b>12</b>

<b>Chapter 5 Cast Screen .....</b>	<b>13</b>
<b>Chapter 6 Maintenance.....</b>	<b>14</b>
<b>6.1 View Device Information .....</b>	<b>14</b>
<b>6.2 Upgrade Device .....</b>	<b>14</b>
<b>6.3 Set Time and Date.....</b>	<b>15</b>
<b>6.4 Restore Device.....</b>	<b>15</b>

# Chapter 1 Overview

## 1.1 Device Description

The acoustic leak detector is a high-performance device designed for technicians and plumbers to find leaks in plumbing, water service, and residential or commercial properties. The device has four ranges of selectable digital band pass filters, and the amplification is up to 80 dB. The filtration and amplification of the sound frequencies can help you locate the leakage sites accurately. It can be widely used with the handheld sensor and pick-up sensor correspondingly. Furthermore, it can detect the ignored leaks, reducing the resource waste and property loss.

## 1.2 Main Function

### Inspection

Device supports the inspection and quick inspection of leaks.

### Wide Frequency Range

Device supports multiple ranges of selectable digital band pass filters.

## 1.3 Appearance

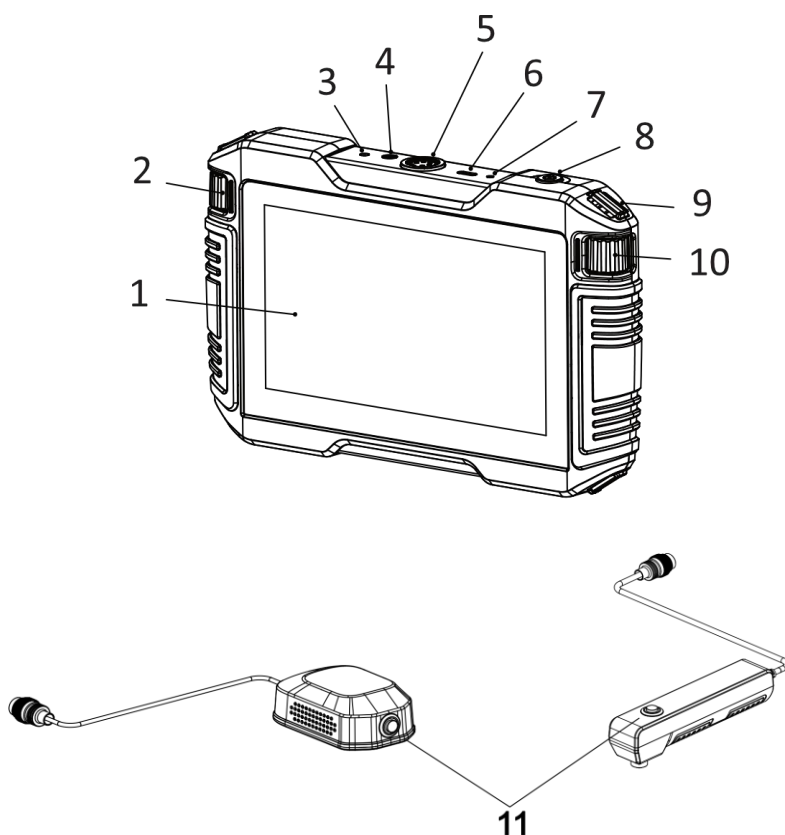

**Figure 1-1 Appearance**

**Table 1-1 Button and Interface Description**

No.	Description	Function
1	Touch Screen	<ul style="list-style-type: none"> <li>● Show the live view interface.</li> <li>● Touch-screen operation.</li> </ul>
2	Volume Wheel	Adjust the headset volume.
3	Reboot Key	Press to restart the device.
4	Headset Jack	Connect the headset to the device.
5	Sensor Interface	Connect the handheld sensor or pick-

No.	Description	Function
		up sensor to the device.
6	Type-C Interface	Charge the device or export files with Type-C cable.
7	Indicator	Indicate the charging status of the device. <ul style="list-style-type: none"> <li>● Solid red: charging normally</li> <li>● Solid green: fully charged</li> </ul>
8	Power Key	<ul style="list-style-type: none"> <li>● Press: standby mode/wake up device</li> <li>● Hold: power on/off</li> </ul>
9	Neck Strap Attachment Point	Mount the neck strap.
10	Leakage Detection Level Switch	Switch the frequency ranges according to the detection environment.
11	Sound Collection Button	Hold to start receiving the audio signal from the handheld sensor or the pick-up sensor and release to stop receiving the audio signal.

 **Note**

Only when you release the sound collection button can you see the audio data display.

## Chapter 2 Preparation

### 2.1 Assemble Accessories

---

#### Note

- Tighten all the connectors to prevent to damage the equipment.
  - Please assemble the accessories as request. If you need to detect the leaks in the wall, you can select to mount the pick-up sensor. If you need to detect the leaks under the ground, you can select to mount the handheld sensor.
- 

#### 2.1.1 Mount the Neck Strap

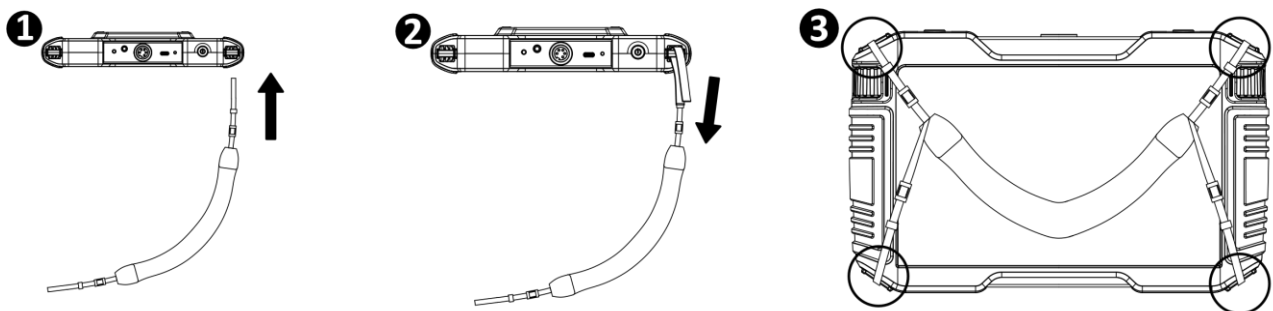
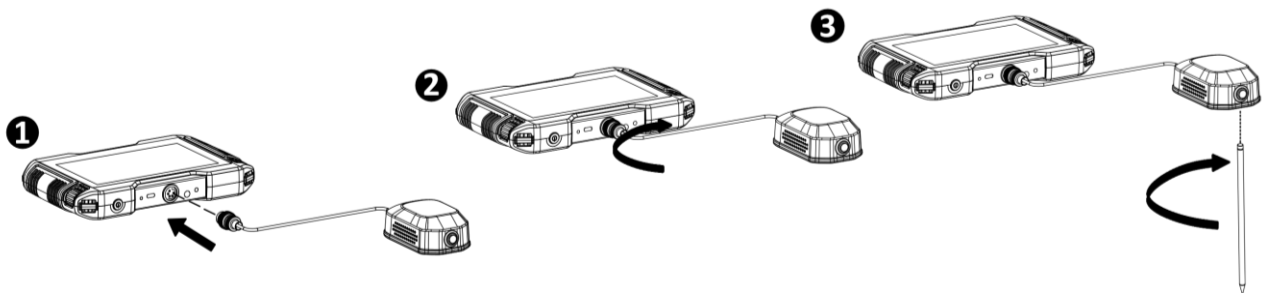

Figure 2-1 Mount the Neck Strap

#### 2.1.2 Mount the Handheld Sensor





## Figure 2-2 Handheld Sensor

### 2.1.3 Mount the Pick-up Sensor

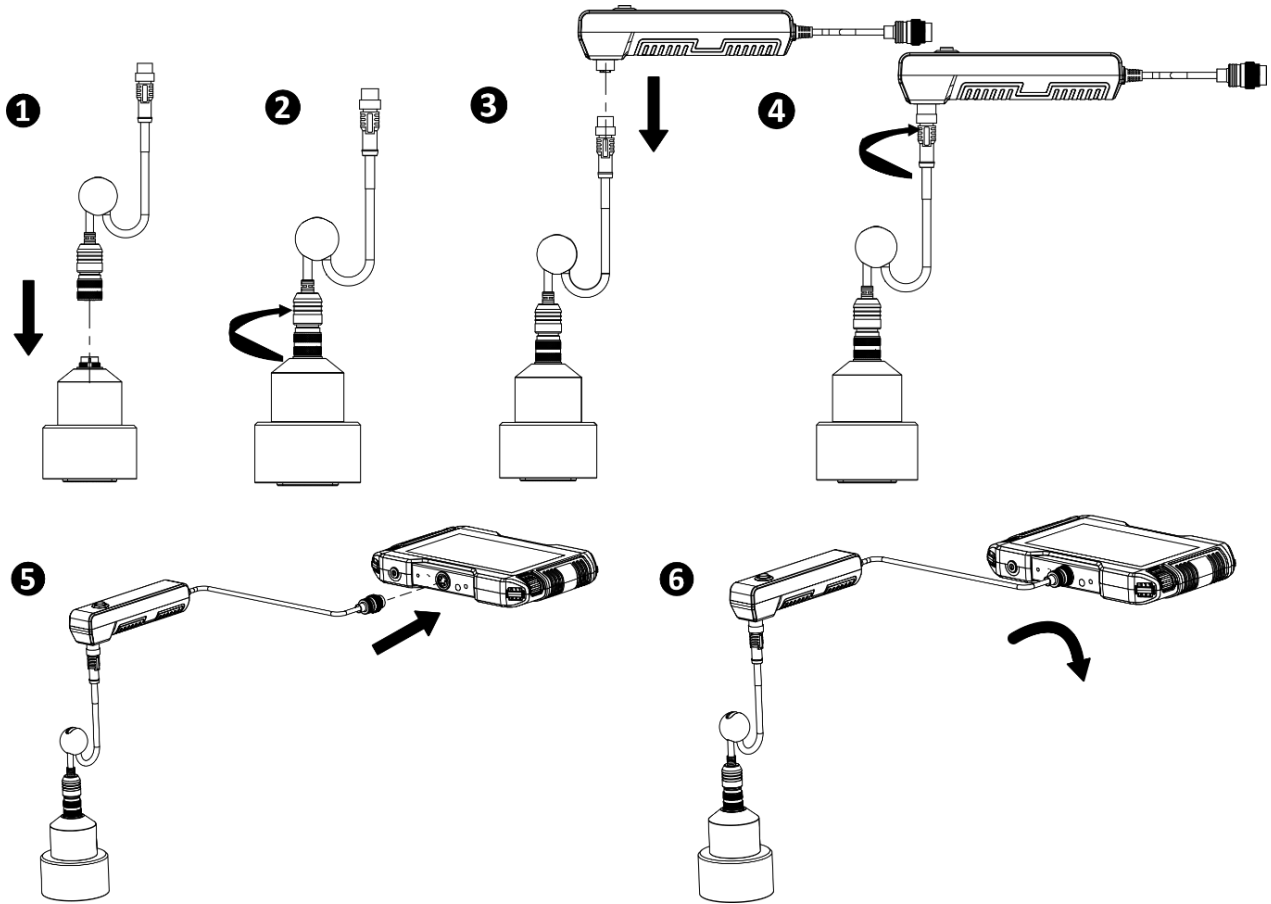

Figure 2-3 Pick-up Sensor

## 2.2 Power On/Off

### Power On

Hold  for over three seconds to turn on the device.

 **Note**

To fully charge the battery of the device before first use, the following requirements should be met:

- Charge the device for more than 6 hours before first use.
  - A solid green indicator light shows when the battery is fully charged.
- 

## **Power Off**

When the device is turned on, hold  for about three seconds to power off the device.

### **2.2.1 Set Auto Power-off Duration**

#### **Steps**

1. Go to **Local Settings > Device Settings > Auto Power-off**.
2. Tap  to set the automatic shutdown time for device as required.

## **2.3 Set Auto Sleep**

#### **Steps**

1. Go to **Local Settings > Device Settings > Auto Sleep**.
2. Tap  to set the automatic sleep time for device as required.

## **2.4 Swipe-Down Menu**

In the observation interface, swipe down to call the swipe-down menu. You can tap to quickly enable **USB Cast Screen** or switch the dark or light mode.

## Chapter 3 Display Settings

### 3.1 Display Appearance

Go to **Local Settings > Device Settings > Appearance** to select the light or dark mode.

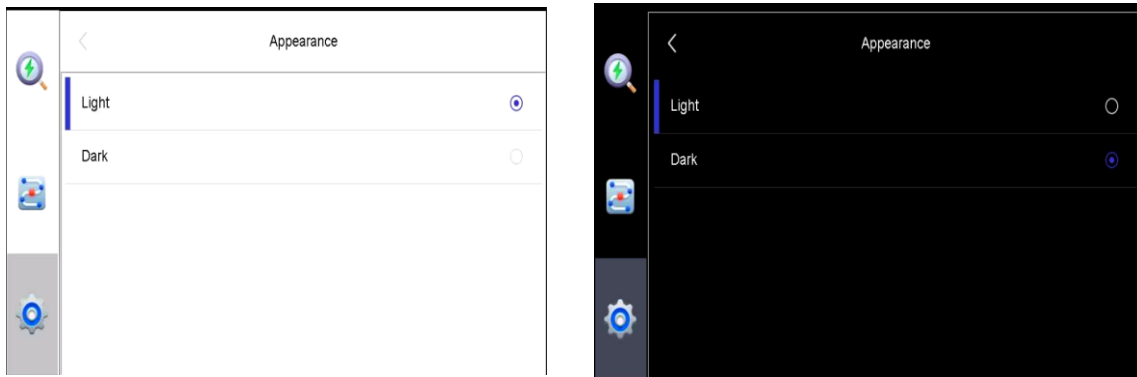

Figure 3-1 Display Appearance

### 3.2 Set Screen Brightness

You can drag the brightness adjustment bar in the swipe-down menu.

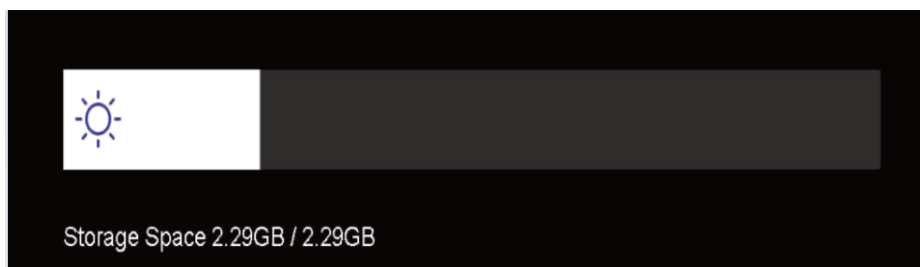

Figure 3-2 Display Appearance

---

#### Note

You can also go to **Local Settings > Device Settings > Display Brightness** to drag the brightness adjustment bar as required.

---

### **3.3 Display OSD Info**

Go to **Local Settings > Device Settings > Display Settings** to enable the information on-screen display.

#### **Time and Date**

The time and date of the device.

#### **Status Icons**

The icons of storage space and the battery status.

#### **Brand Logo**

The brand logo is displayed on the upper right of the screen.

## Chapter 4 Leakage Sites Inspection

The acoustic leak detector can detect the leakage sites by the pick-up sensor, handheld sensor, and listening stick. You can put the sensors or the listening stick on the leakage sites and the sensors will send the audio signal to the device. Furthermore, you can tell the leaks by combining the audio signal of the device and the sound from the headset.

The leakage sites inspection contains route inspection and quick inspection. The quick inspection helps you detect the leak area quickly, and the route inspection helps you detect the leakage sites accurately.

### 4.1 Quick Inspection

You can detect the leak area quickly by moving the sensors or the listening stick to collect the audio amplitude.

#### Steps

1. Place the sensors near the possible leakage site.
2. Hold Sound Collection button to collect the audio signals of the current site, and release to complete the collection.

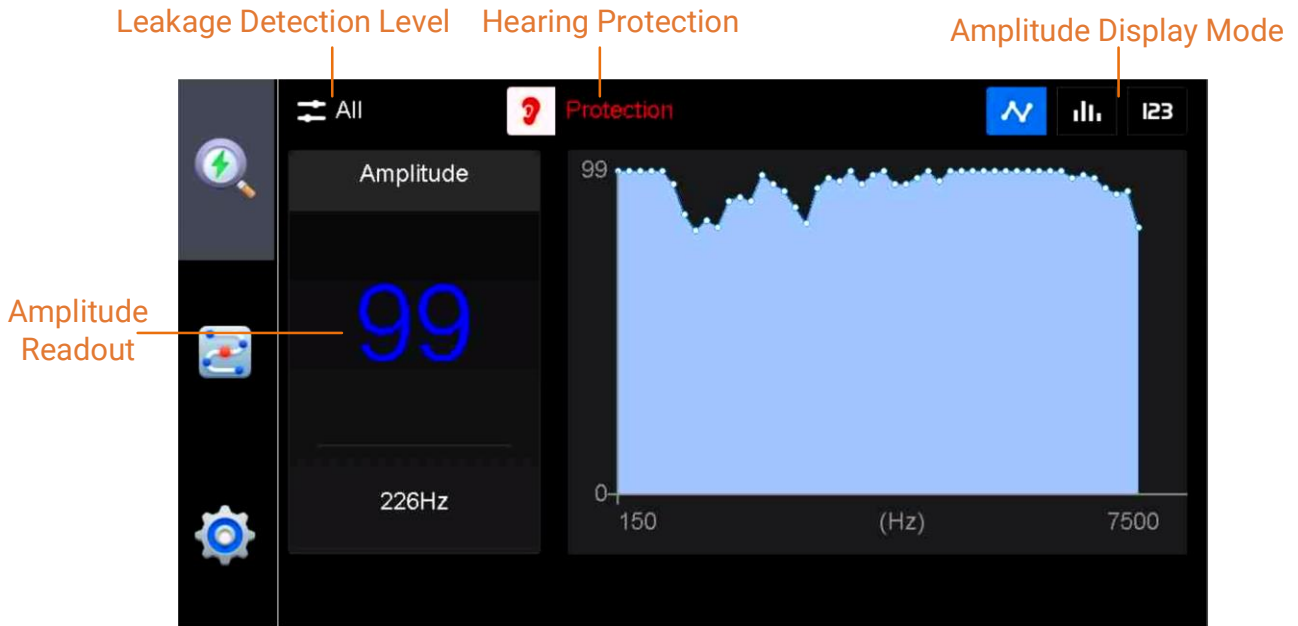

**Figure 4-1 Quick Inspection**

- Leakage Detection Level: Switch the frequency ranges of the band pass filters according to the detection environment.
  - **Low**: Indoor low frequency, ranging from 150 Hz to 3000 Hz.
  - **Mid**: Indoor mid-frequency, ranging from 3000 Hz to 6000 Hz.
  - **High**: Indoor high frequency, ranging from 4500 Hz to 7500 Hz.
  - **All**: Indoor all-pass, ranging from 150 Hz to 7500 Hz.
- Hearing Protection: The symbol of hearing protection will be displayed when the device receive high volume or pitch sound suddenly. If it is displayed, the equipment will lower the volume automatically.
- Amplitude Display Mode: Select line chart, bar chart or the figure to display amplitude.

**Note**

The horizontal axis of the graph represents the frequency ranges of the band pass filters and the vertical axis of the graph represents the amplitude.

## 4.2 Route Inspection

You can locate the leakage sites accurately by collecting and analyzing several audio amplitudes in sites.

### 4.2.1 Collect Possible Leakage Sites

The device can collect the amplitudes of the possible leakage sites.

#### Steps

1. Tap one of the sites, then the device starts to collect the amplitudes of the possible leakage sites.
2. Tap again when the amplitude is stable. Then the average amplitude will be displayed on the top of the current site.

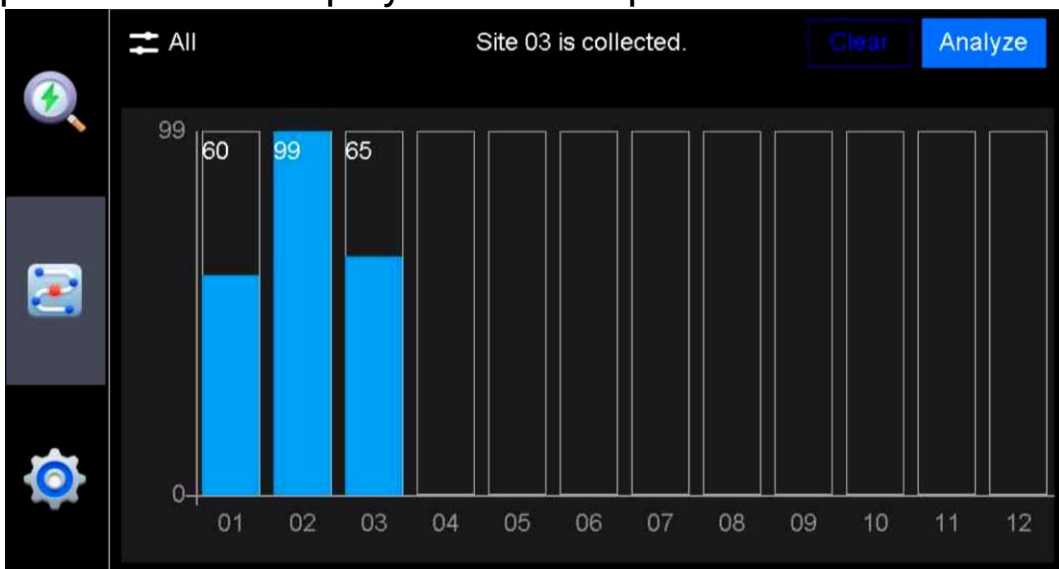

**Figure 4-2 Route Inspection**

---

#### Note

- You can refresh the data at the same site.
  - Tap  to clear the audio amplitudes of all the sites.
  - The horizontal axis of the graph represents the detected sites number and the vertical axis of the graph represents the amplitude.
-

### 4.2.2 Analyze Site Data

Tap **Analyze** to analyze all the sites which have been collected and the possible leakage site will be marked in red.

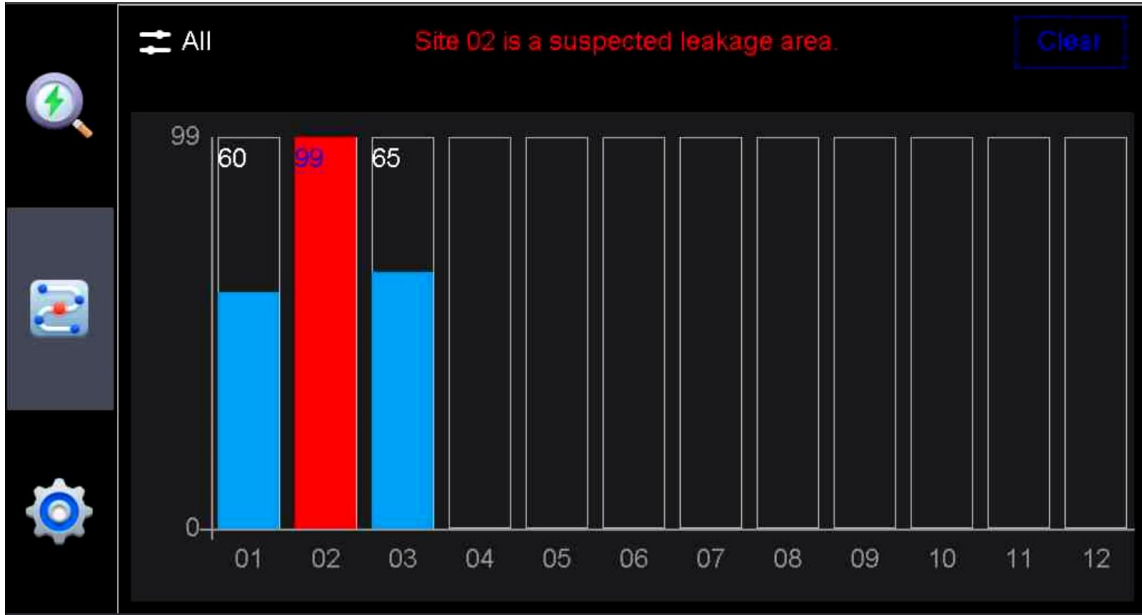



Figure 4-3 Route Inspection Analysis



## Chapter 5 Cast Screen

The device supports casting screen to PC by UVC protocol-based client software or player. You can connect the device to your PC via a type-C cable, and cast the real-time live view of the device to your PC.

### Steps

1. Go to **Local Settings > Connections > USB Cast Screen** to turn on the function on device. Or tap  in the swipe-down menu to turn on/off **USB Cast Screen**.
2. Open the UVC protocol-based client software on your PC.
3. Use a type-C cable to connect your device with PC.

## Chapter 6 Maintenance

### 6.1 View Device Information

Go to **Local Settings > Device Information** to view the device information.

### 6.2 Upgrade Device

#### Steps

1. Connect the device to your PC with cable and open the detected disk.
2. Copy the upgrade file and paste it to the root directory of the device.
3. Disconnect the device from your PC.
4. Reboot the device and go to **Local Settings > Device Settings**. Tap the icon of the upgrade file and then the device will reboot automatically. The upgrading process will be displayed in the main interface.

---

#### **Note**

After upgrading, the device reboots automatically. You can view the current version in **Local Settings > Device Settings > Device Information**.

---

## 6.3 Set Time and Date

### Steps

1. Go to **Local Settings > Device Settings > Time and Date**.
  2. Set the time and date.
  3. Tap < to save and exit.
- 

### Note

Go to **Local Settings > Device Settings > Display Settings** to enable or disable time and date display.

---

## 6.4 Restore Device

Go to **Local Settings > Device Settings > Device Initialization** to restore the storage space and the parameter.

### Format Memory

Restore the storage space.

### Restore

Initialize the device and restore default settings.

---

### Note

Please back up the important files before the initialization.

---



**HIKMICRO**

See the World in a New Way