

M31 Handheld Thermography Camera



HIKMICRO M31 handheld camera is specially designed for temperature measurement. It's equipped with a 384 x 288 resolution thermal detector. It helps the staff to quickly find the high-temperature targets in the environment. Meanwhile, it provides assistance with decisions and ensures safety. The device is mainly applied to various industries, such as Building, HVAC, auto industry, etc.

▪ Features

- High sensitivity thermal module with 384 x 288 resolution
- Leading thermal image processing technology: Adaptive AGC, DDE, 3D DNR
- Supports multiple palettes
- High quality optical module with 8 MP resolution
- Bi-spectrum image fusion, picture-in-picture preview
- Wide temperature measurement range: -20°C~650°C
- High temperature measurement accuracy: Up to $\pm 2^{\circ}\text{C}$, $\pm 2\%$
- 640 x 480 resolution 3.5" LCD touch display
- Long-distance laser light supplement for thermography targets
- LED light supplement makes the device a torch in required scenarios
- Supports 1.0x to 8.0x continuous digital zoom

▪ Specification

Infrared Image	
IR Resolution	384 x 288 (110,592 pixels)
SuperIR	768 x 576 (442,368 pixels)
NETD	< 30mK (@ 25 °C, F#=1.0)
Image Frequency	50Hz
Detector Pitch	17 μm
Spectral Range	7.5 to 14 μm
Focal Length	6.4mm
F-number	F1.0
Field of View (FOV)	41.1°×30.5°
Spatial Resolution (IFOV)	1.87 mrad
Min. Focus Distance	0.1 m (0.32ft)
Focus Mode	Manual Focus
Image Display	
Visual Camera	3264 × 2448 (8 MP)
Display	640 × 480 Resolution, 3.5" LCD Touch Screen
Screen Brightness	Manual
Digital Zoom	1.0x to 8.0x continuous
Color Palettes	White Hot, Black Hot, Rainbow, Ironbow, Red Hot, Fusion, Rain, Blue Red
Focus Mode Palette	Above/Below/Interval
Color Alarm	Above/Below/Interval/Insulation
Image Modes	Thermal/Visual/Fusion/PIP/Blending
Measurement and Analysis	
Object Temperature Range	-20 °C to 650 °C (-4 °F to 1202 °F)
Accuracy	Max (±2°C/3.6°F, ±2%), for the ambient temp. 15°C to 35°C (59°F to 95°F) and object temp. above 0°C (32°F)
Measurement Tools	Center Spot, Hot Spot, Cold Spot User-definable: 10 spots, 1 line, 5 rectangles, and 5 circles
Level and Span Mode	Auto/Manual/1-Tap Touch-screen
Data Storage and Communication	
Storage Media	Removable 64 GB Micro SD Card
Image Storage Capacity	Approx. 100,000 Images
Annotations	Voice note: max. 60 seconds; Text note: max. 200 characters
Video Storage Capacity	Approx. 300 hours
Video File Format	MP4 video and radiometric video
General	
Wi-Fi	802.11 b/g/n (2.4 GHz and 5 GHz)

Bluetooth	Bluetooth 4.2
USB Interface	USB Type-C
LED Light	Yes
Laser	Yes, Class II, Wavelength: 635 nm; Power: < 1 mW
Battery Type	Interchangeable and rechargeable Li-ion battery
Battery Operating Time	Approx. 4 hours
Battery Charging Time	Approx. 4 hours fully charged
Power Saving Mode	Yes
Protection Level	IP54
Drop Test Height	2 m (6.56 ft)
Safety	IEC 61010-1
EMC	EN 50130-4, EN 55032, EN IEC 61000-3-2, EN 61000-3-3
Vibration	2g, IEC 60068-2-6
Shock	25g, IEC 60068-2-27
Working Temperature Range	-20°C to 50°C (-4°F to 122°F)
Storage Temperature Range	-40°C to 70°C (-40°F to 158°F)
Relative Humidity	< 95% non-condensing
Weight	Approx. 720g (1.59 lb)
Dimension	244 × 100 × 104 mm (9.6 × 3.9 × 4.1 in)
Tripod Mounting	UNC ¼" -20





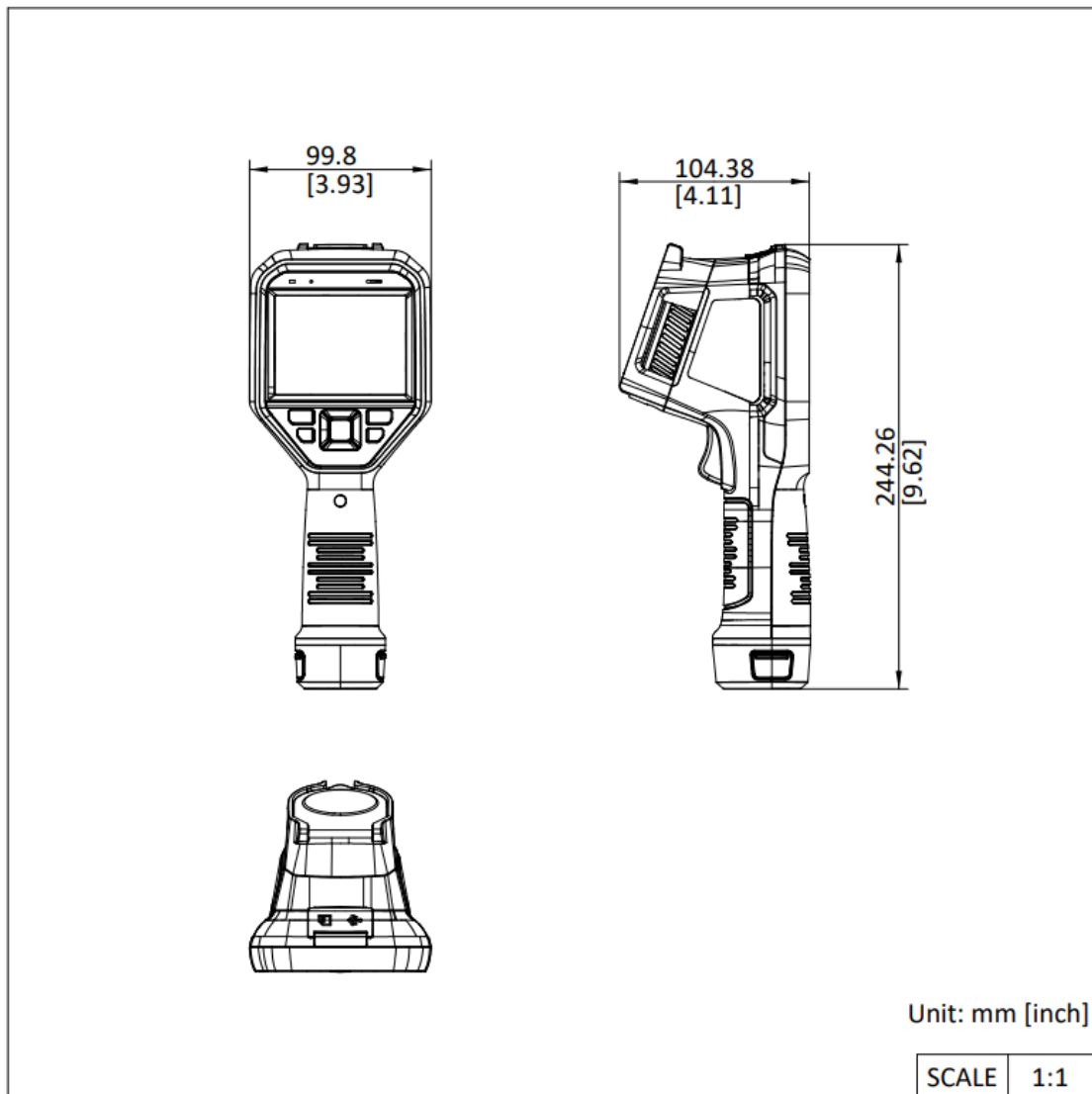

▪ Available Model

HM-TP23-7QF/W-M31

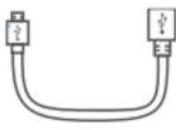
▪ Dimension



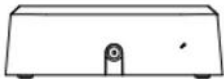
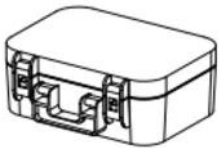



▪ Packaging List

			
QSG (× 1)	USB 2.0 A to USB Type-C Cable (× 1)	Power Supply for Battery Charger (× 1)	International Use Plugs (US/EU/UK/AU) for Power Supply
			
Battery (× 2)	Two-bay Battery Charger (× 1)	Hard Carrying Case (× 1)	Wrist Strap (× 1)
			
Calibration Certificate			

▪ Accessory

▪ Optional

E097-13-1S1P26650 M Series Battery	HM-5202ZC M Series Charging Base	HM-2925ZJ-TM01- BRACKET Tripod Mounting Bracket	HM-SP01-POUCH M/G/SP Series Pouch
			

COMPLIANCE NOTICE: The thermal series products might be subject to export controls in various countries or regions, including without limitation, the United States, European Union, United Kingdom and/or other member countries of the Wassenaar Arrangement. Please consult your professional legal or compliance expert or local government authorities for any necessary export license requirements if you intend to transfer, export, re-export the thermal series products between different countries.



 Hikmicro Industrial

 hikmicro_industrial

 HIKMICRO Industrial

 HIKMICRO

 info@hikmicrotech.com

 www.hikmicrotech.com

© Hangzhou Microimage Software Co., Ltd. All Rights Reserved.

*Note: Specifications are subject to change without notice. For the current specs,
please go to www.hikmicrotech.com