

Product Manual



Declaration

The manual is only used for this series product. All rights reserved.

Because the editing time is limited, we do not guarantee that there is no error in this manual. As this manual is used as product series manual, however, the configuration and function of different products may be different, about the specific specification and function, the technic requirements when you purchasing is the only reference. For the manual amendment, we have no responsibility and obligation to inform any company or individuals.

MENU

Instruction Before Use.....	2
Main configuration:	2
Application.....	5
After-service.....	5
Warning.....	5
1. Brief Introduction.....	6
1.1 Parameters.....	6
2. Operation Steps.....	8
2.1 Take out the instrument.....	8
2.2 Boot Preparation.....	8
2.3 Operation.....	8
2.4 Probe articulation control.....	9
2.5 After use.....	9
3. Image Capture and Operation.....	9
3.1 Photo/Video.....	9
3.2 Playback.....	9
3.3 LED light control.....	10
3.4 Function bar.....	10
3.4.1 Function Setting.....	10
3.4.2 Image adjusting.....	11
3.4.3 Image effect.....	11
3.4.4 Image freezing.....	11
3.4.5 Scale.....	11
3.4.6 Aspect Ratio.....	12
4. Solution to Common Problems.....	12

Instruction Before Use

Main configuration:



For the specific configuration, please refers to the packing list.

Name	Specs	Qty	Remake
Case	400mm*310mm*130mm	1	
Videoscope	277mm*106mm*92mm	1	
TFcard	16G	1	Embed
Battery	18650	1	Embed
Micro USB cable	1m	1	
Card reader	USB2.0	1	
Adaptor	5V2A	1	

Button and Port

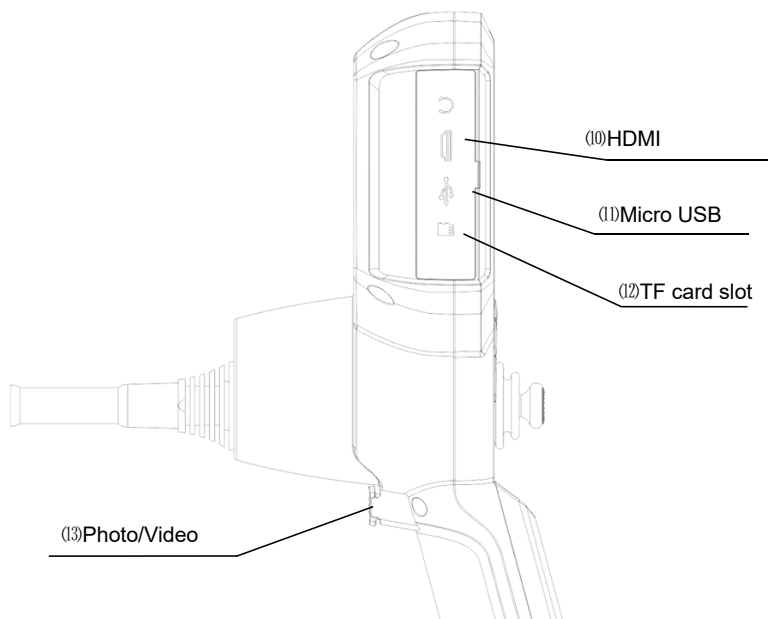
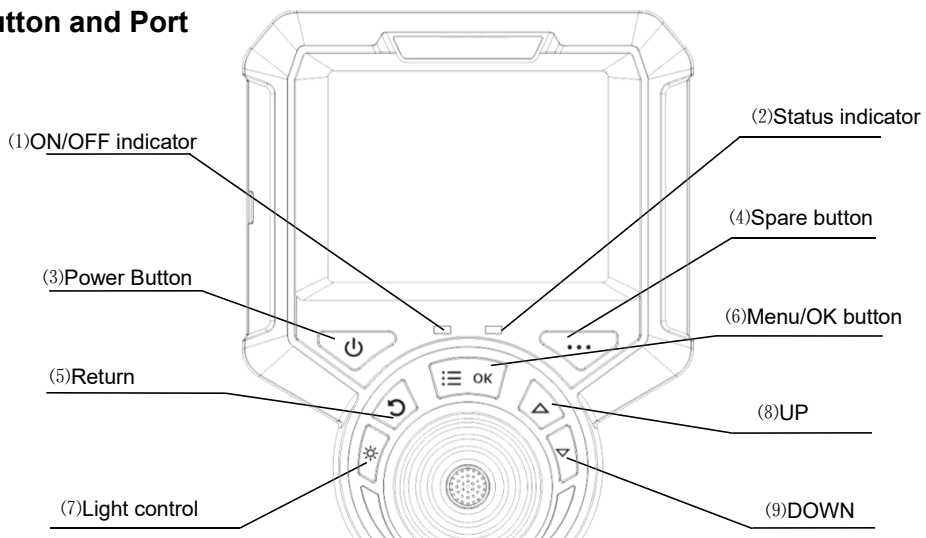

- (1) On/off indicator light: the color is white, which flashes twice during starting up, and twice during equipment operation.
- (2) Status indicator: the colors are red, orange and blue. Red will be displayed during charging. Orange will be displayed after charging.
- (3) Power button: used for switching equipment.
- (4) Spare button: as the optional function of the use of the button.
- (5) Return button: in various states, you can return to the upper level.
- (6) Menu/OK button: in the preview state, you can view the function bar, and select the corresponding function by "scroll up" and "scroll down". Press this key to switch the function sub-options.
- (7) Light control button: adjust the brightness level of endoscope light source, and switch from 0 to 5 levels.
- (8) Up button: in the function bar, system Settings, file management, this key as the up key; You can enlarge the image in the preview.
- (9) Down button: in the function bar, system Settings, file management, this key as the down selection key; You can zoom out in the preview.
- (10) HDMI video output: for output video signal, external HDMI video equipment.
- (11) Micro USB charging port: used for charging equipment, charging voltage 5V, current 1A.
- (12) TF card slot: external TF card, as the device memory.
- (13) Photo/video button: used for taking and recording photos and videos of the device; It is also used as a confirmation key in the Settings menu.

Application

This product is only applied in the real-time detection and analysis for industrial equipment and automobile production and maintenance. As a tool videoscope, it can also be used for home inspection of sewer lines, ceiling tops, dead corners, etc.

After-service

This product has not any spare parts which can be repair by users. Any disassemble, refit or maintenance is not allowed. If damage and losses caused by this, we do not assume any responsibility. The product maintenance is only afforded by the authorized dealers and distributors.

Warning

warning

- Prohibit the use of this instrument to observe the body or the animal's body;
- Do not use the product to inspect equipment in action;
- Do not use or store the product on explosive, strong electromagnetic field or with combustible gas, otherwise it may cause fire or explosion;
- Do not use the product to check objects with current carrying, so as to avoid the occurrence of electric shock;
- Do not remove the battery cover without permission. If you need to remove the battery cover, please communicate with the technical staff of the manufacturer for confirmation. Those who destroy it without authorization shall be held responsible;
- Do not watch the LED light source at the end of the lens straightly, avoiding the effect of strong light on the visual acuity;
- Never excessive bending, stretching, twisting, rolling cable, otherwise it may cause cable disconnect, a fire or electric shock accident;
- If there is abnormal in the angle adjustment operation, stop the current operation, and turn off. Then contact the supplier;

- Keep the insert tube away from any liquid, except water, salty water or oil;
- When finish using, please clean the front section of the instrument in time, to prevent corrosion.

1. Brief Introduction

1.1 Parameters

Probe diameter (mm)	Φ6
Probe length (mm)	13±0.3
Probe material	Super wear-resisting alloy
Camera Pixels	1,000,000
DOV	7mm~110mm (optional 20mm~150mm)
FOV	120°
Viewing Direction	0° front view
Illuminance	Max 25000Lx
Tube Material	tungsten-braided
Tube Length	1m/1.5m
Protecting Device of Durability	buffer protection device between the host and wear-resistant tube
Articulation	360° all-way
Bending Angle	≥220°
Display	3.5" IPS
Display Resolution	640*480
Photo/Video Format	JPG/MP4
Photo Resolution	960*720/1280*720

Video Resolution	960*720/1280*720
Zoom function	Image 5X
WIFI Function	WIFI (optional)
Temperature Alarm	Temperature Sensor (optional)
Outer Case Material	anti-fall engineering alloy material
Water/Dust Proof	probe/tube: IP67 monitor:IP65
Monitor Structure	one hand-held monitor
Memory	standard TF card 16G, maximum: 64G
Data Port	HDMI port/Micro USB port
Batteries	built-in lithium batteries
Working Time	≥3H
Battery Capacity	3.7V, 3200mAh
Power Consumption	3.5W
Power Charge	DC5V, maximum current:1A
Weight	≤0.5kg (including 2 batteries)
Compatibility	Optional with multifunctional accessories
Store Temperature	-23°C~63°C
Relative Humidity	maximum: 92%, non-condensing
Monitor Working Temperature	--15°C~50°C, when 0°C below, the display needs preheating.
Camera Working Temperature	-25°C~80°C, when 0°C below, please reduce probe articulation.

2. Operation Steps

2.1 Take out the instrument

Open the instrument case, while taking out the instrument host, set aside and pay close attention to the probe; avoid colliding the probe and scratching probe lens.

2.2 Boot Preparation

Visually check whether the appearance of the videoscope is intact, insert the TF card, straighten the insertion tube, and adjust the direction of the probe to 0°.

2.3 Operation

It supports for 10 levels of brightness adjustment. Press the light control button to suitable brightness. Slowly insert the tube to the inspected object. The operation interface is as follows:

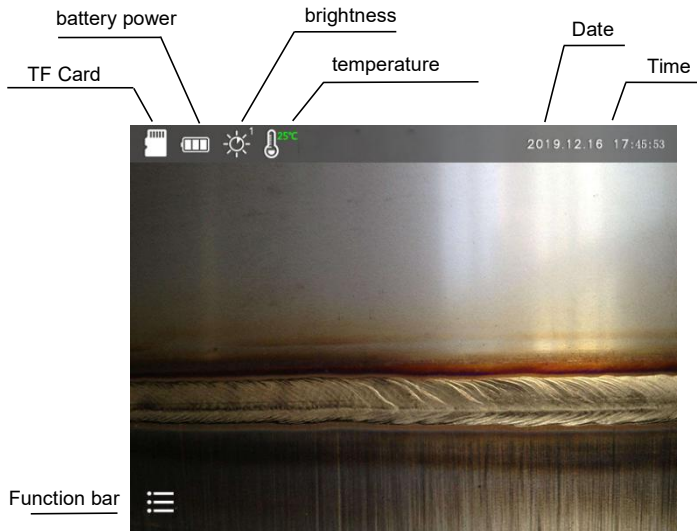

Note: the probe temperature alarm is shown as an optional function, no function, no icon.

2.4 Probe articulation control

According to the testing need, operate the joystick to control probe articulation, in order to observe. The bending motion of the front probe is controlled by rotating the joystick. During the operation, if the joystick suddenly meets larger resistance, or there is any abnormality, please immediately stop using. After adjust the joystick to the middle position, please remove the insert tube carefully from the testing equipment.

2.5 After use

Before you remove the insert tube from the inspected object, please make sure the probe is reset to be straight. If the product is damaged due to improper operation, the user bears the loss. Turn off the power switch, put the instrument into the portable case carefully, and put the tube into the case well.





3. Image Capture and Operation

3.1 Photo/Video

- ① Short press “(13) photo/video button” to take photo;
- ② Long press 2nds “(13) photo/video button” to take video. Long press 2nds again to exit. In video-taking mode, short press it to capture image.
- ③ The saved file is named in the form as follows:

20200215-131702.JPG
YTD hour/min./sec.





3.2 Playback

In preview mode, press  “**playback**” button, it will change to image playback mode. Press  “**up**” button or  “**down**” button to select and press  “**menu/OK**” button to playback different images (.jpg) or videos (.mov). Press  “**light control**” button to delete files.

3.3 LED light control

In preview mode, Press  “light control” button to adjust LED light from level “0” to level “6”.

3.4 Function bar

Press  “menu/OK” to open function bar, as following picture. Press  “UP”、 “DOWN” to select one of function, then press  “menu/OK” to confirm.

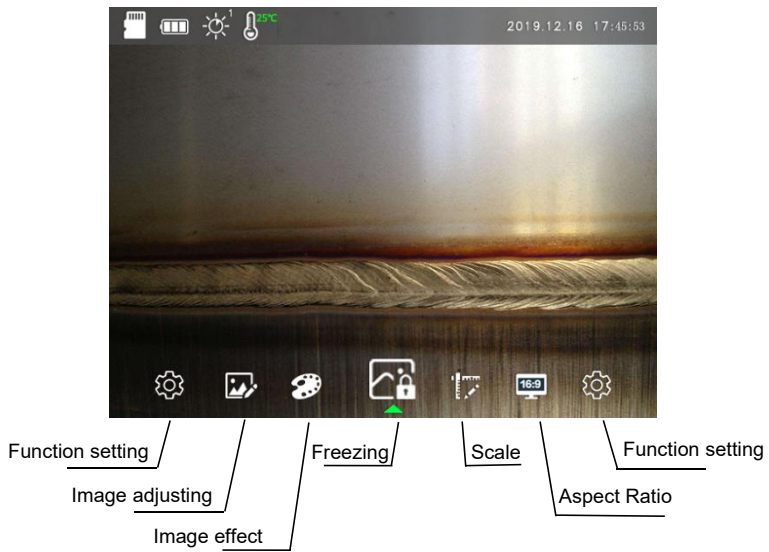

3.4.1 Function Setting

 : System Setting, press the camera key/OK button to enter the secondary menu options.

 : Format, format the TF memory card, please note that the file will be emptied.

 : Time setting, set the system time.

 : Restore factory Setting, restore device setting to the factory state.

 : Version number, device software version number.

3.4.2 Image adjusting

 : Image parameters setting or default parameters restoring.

 : Gamma parameters setting.

 : Sharpness parameter setting.

 : Brightness parameter setting.

3.4.3 Image effect

 : Image normal display.

 : Image warm color display.

 : Image cold color display.

3.4.4 Image freezing

 : Freeze preview image.

 : Unlock frozen preview image.

3.4.5 Scale

 : Scale, software virtual scale function.



: Display contrast measuring length scale.



: Display contrast measuring diameter scale.

3.4.6 Aspect Ratio



: Adjust image scale to 4:3.



: Adjust image scale to 16:9.

4.Solution to Common Problems

Problem	Reason	Solution
Boot without reaction	dead battery	charging
Auto shutdown	battery power shortage	charge or change battery
Boot screen freezing	system boot failure or battery power shortage	remove the battery to re install or charge, or forced shutdown by triggered the side round hole(under TF card)
The image cannot be recorded or found	the capacity of TF card is not enough	replace TF card or delete useless files
Image stuck and fail to turn off	system stuck	forced shutdown by triggered the side round hole(under TF card)

