

# Product Manual



 Please read the manual before using the equipment.



# Declaration

The manual is only used for this series of products.

Because the editing time is limited, we do not guarantee that there is no error in this manual. As this manual is used as product series manual, however, the configuration and function of different products may be different, about the specific specification and function, the technic requirements when you purchasing is the only reference. For the manual amendment, we have no responsibility and obligation to inform any company or individuals.

---

# MENU

Instruction Before Use.....	1
Main Configuration.....	1
Button and Port.....	2
Application.....	4
After-service.....	4
Warning.....	4
1 Brief Introduction.....	5
1.1 Parameters.....	5
2 Operation Steps.....	7
2.1 Take out the instrument.....	7
2.2 Boot preparation.....	7
2.3 Operation.....	8
2.4 Probe articulation control.....	9
2.5 After use.....	9
3 Image Capture and Operation.....	10
3.1 Photo/Video.....	10
3.2 Temperature indication & alarm (optional, not standard configuration).....	10
3.3 Image special effects.....	11
3.4 Exposure control.....	11

---

3.5 Playback.....	11
3.6 Measuring function(optional, not standard configuration)....	11
3.7 Zoom in/out.....	11
3.8 Language setting.....	12
3.9 Date&Time setting.....	12
3.10 Auto shut off.....	12
3.11 Date Stamp.....	12
3.12 Formatting.....	13
3.13 Factory reset.....	13
3.14 Firmware update.....	13
<b>4 Solution to Common Problems.....</b>	<b>11</b>

---

## Instruction Before Use

### Main Configuration



For the specific configuration, please refers to the packing list.

Name	Specs	Qty	Note
Case	432*386*163 mm <sup>3</sup>	1	
Videoscope	324.3*161.3*91.2mm <sup>3</sup>	1	
Base	215*84*36mm <sup>3</sup>	1	Optional
TF card reader		1	
Rechargeable Battery	φ18mm×65mm	2	
Micro USB Line	1m	1	
Charger		1	

## Button and Port

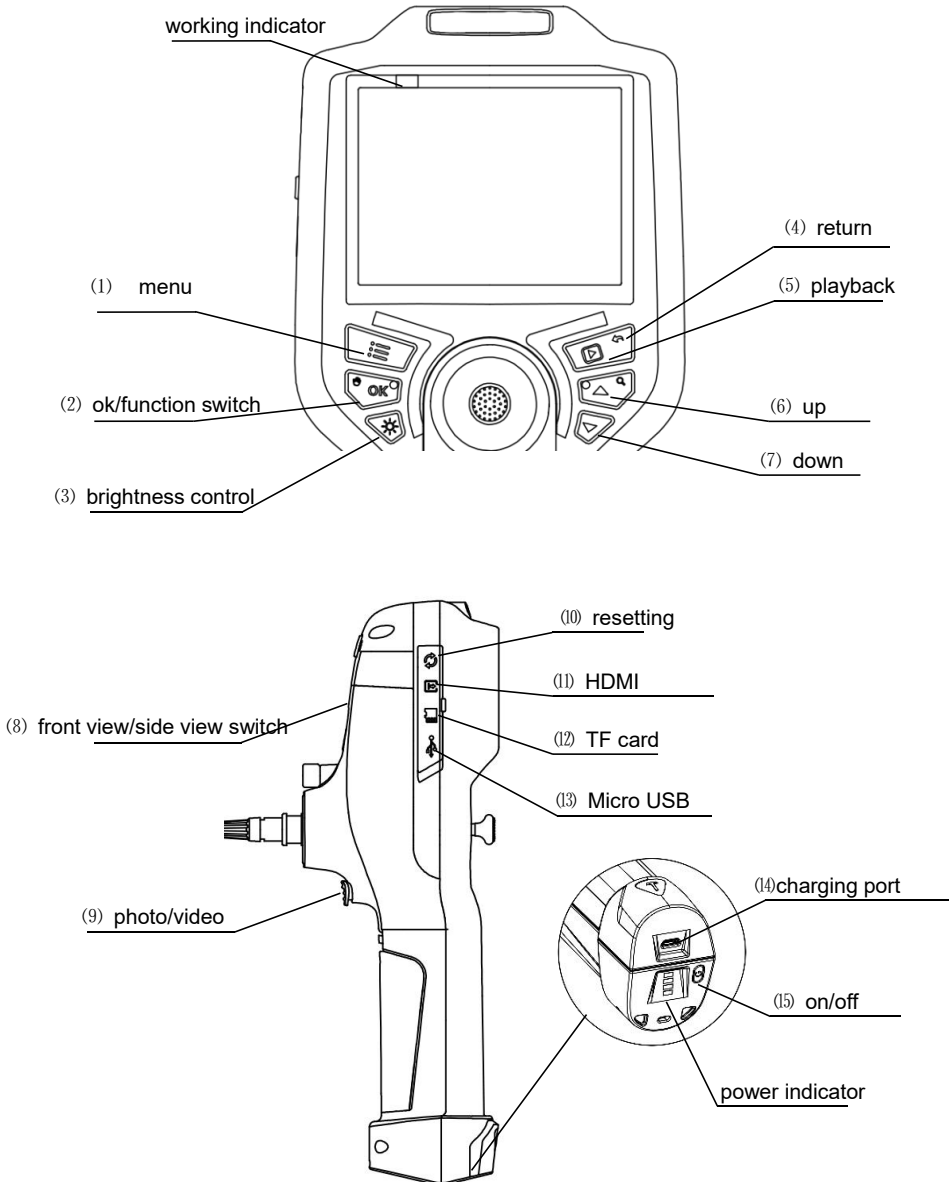

- 
- (1) Menu: function setting including language setting/ time setting /firmware update.
  - (2) Ok: in menu setting mode, it serves as a validation button; in preview mode, press ok button, it serves as function switch button.
  - (3) Brightness control: control the light from 0-9 levels.
  - (4) Return: return to previous menu.
  - (5) Playback: in preview mode, press this button, it will go to image/video playback page.
  - (6) Up: in menu setting mode, press this button to upward navigation; in preview mode, after pressing OK button, it can adjust the relative function variable.
  - (7) Down: in menu setting mode, press this button to downward navigation; in preview mode, after pressing OK button, it can adjust the relative function variable.
  - (8) Front view/side view switch: In preview mode, press this button to switch between front view and side view lens. (only available for dual lens model)
  - (9) Photo/video: short press for taking photo, long press for taking video. In video mode, short press for snapping a picture.
  - (10) Resetting: when the monitor does not work for abnormal reason, press this hole by needle, it will restart.
  - (11) HDMI: connect the monitor with display by HDMI cable, the image on the monitor will be displayed synchronously on the display.
  - (12) TF card: please use Class 10 or above TF card. Maximum: 32G.
  - (13) Micro USB: When the monitor works independently, it serves as power input port. When it connects with power bank or mobile phone charging adapter, the monitor will turn on automatically.
  - (14) Micro USB charging port: power charging: DC5V, maximum current:1A.
  - (15) On/off: Long press this button for 3 seconds to boot; long press it for 3 seconds to shut down. On the status of shut off, short press it, the power indicator will show the current power of the batteries. The



---

current power of the two batteries will be indicated separately, orange light shows the power of inner battery, white light shows the current power of outer battery. When the product is charging, the indicator will flash. When the product is turned on, the indicator will show the current power all the time.

## Application

This product is only applied in the real-time detection and analysis for industrial equipment and automobile production and maintenance.

## After-service

This product has not any spare parts which can be repair by users. Any disassemble, refit or maintenance is not allowed. If damage and losses caused by this, we do not assume any responsibility. The product maintenance is only afforded by the authorized dealers and distributors.

## Warning

### warning

- Prohibit the use of this instrument to observe the body or the animal's body;
- Do not use the product to inspect equipment in action;
- Do not use or store the product on explosive, strong electromagnetic field or with combustible gas, otherwise it may cause fire or explosion;
- Do not use the product to check objects with current carrying, so as to avoid the occurrence of electric shock;
- Do not watch the LED light source at the end of the lens straightly, avoiding the effect of strong light on the visual acuity;
- Never excessive bending, stretching, twisting, rolling cable, otherwise it may cause cable disconnect, a fire or electric shock accident;
- If there is abnormal in the angle adjustment operation, stop the current operation, and turn off. Then contact the supplier;
- Keep the insert tube away from any liquid, except water, salty water or oil;
- When finish using, please clean the front section of the instrument in time, to prevent corrosion.

---

# 1 Brief Introduction

## 1.1 Parameters

Probe Diameter(mm)	Φ8/Φ6/Φ3.9/Φ2.8/Φ2.2/Φ1.8
Camera Pixels	1,000,000 /300,000/160,000
DOF	10mm-100mm
FOV	120°
Viewing Direction	0° front view (optional: 90° sideview)
Illuminance	Maximum:50000lx
Tube Material	Tungsten braided
Tube Length	1.5m (customized for other length)
Protecting Device of Durability	buffer protection device between the host and wear-resistant tube
Articulation	360° all way
Bending Angle	≥160°
Probe Positioning	damping positioning (optional: articulation locking device)
Display	5.1 inches color IPS display, all sight viewing angle
Display Resolution	1280*960
Language	Chinese/English/Russian...8 languages
Image/Video Format	JPEG/MOV
Image Format	1280*720/640*480/400*400
Video Format	1280*720/640*480/400*400
IR Function	IR night vision/ IR thermal imaging (optional)
Outer Case Material	anti-fall engineering alloy material

Water/Dust Proof	probe/tube: IP67
Monitor Structure	one hand-held monitor
Memory	standard TF card 16G, maximum: 32G
Data Port	HDMI port/Micro USB port
Working Time	≥4H, built-in batteries:8H
Batteries	detachable lithium batteries (optional: built-in lithium batteries)
Battery Capacity	3.7V, 3200mAh*2pcs
Power Consumption	2W
Power Charge	DC5V, maximum current:1A
Weight	0.55~0.8kg (including 2 batteries)
Compatibility	replaceable monitor and tube with different diameter
Store Temperature	-23°C~63°C
Relative Humidity	maximum: 92%, non-condensing
Monitor Working Temperature	-30°C~60°C, when 0°C below, the display needs preheating.
Camera Working Temperature	-25°C ~80 °C , when 0°C below, please reduce probe articulation.

---

## 2 Operation Steps

### 2.1 Take out the instrument

Open the instrument case, while taking out the instrument host, set aside and pay close attention to the probe; avoid colliding the probe and scratching probe lens.

### 2.2 Boot preparation

Check whether the insert tube is well connection with the monitor, the TF card and batteries are installed (one battery also works normally). Straighten the insert tube.



- \* Connect the monitor with the tube system;
- \* Make sure the monitor contacting with the upper of the handle tightly;
- \* Lock the button on the back of the monitor;
- \* Install the TF card.

### 2.3 Operation

It supports for 10 levels of brightness adjustment. Press the light control button to suitable brightness. Slowly insert the tube to the inspected object. The operation interface is as follows:

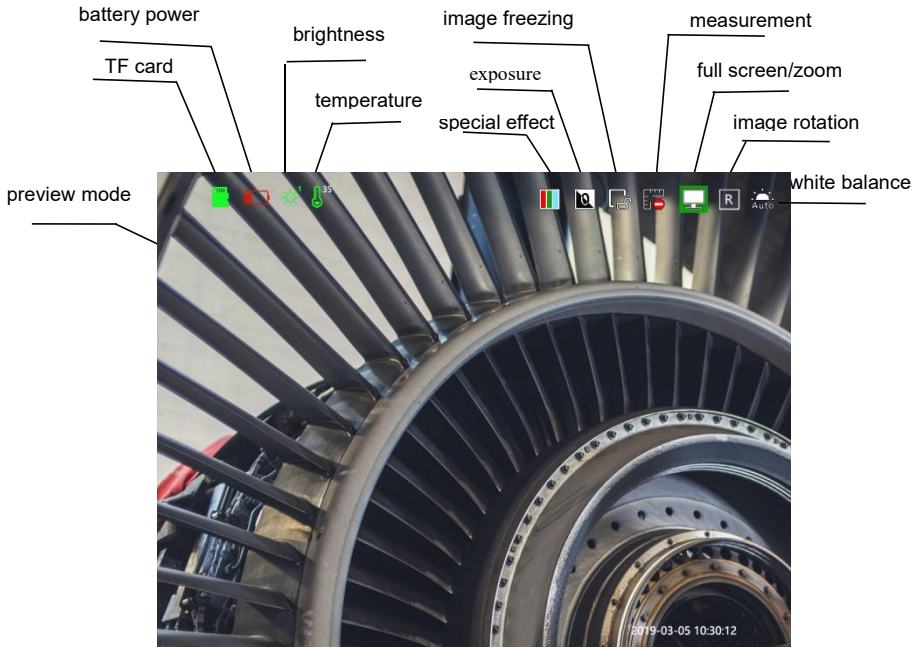

---

## 2.4 Probe articulation control

According to the testing need, operate the joystick to control probe articulation, in order to observe. The bending motion of the front probe is controlled by rotating the joystick. During the operation, if the joystick suddenly meets larger resistance, or there is any abnormality, please immediately stop using. After adjust the joystick to the middle position, please remove the insert tube carefully from the testing equipment.

The articulation lock device is optional. When the probe is articulated to the suitable position, if screw down this device, the articulation will be locked.



## 2.5 After use

Before you remove the insert tube from the inspected object, please make sure the probe is reset to be straight. If the product is damaged due to improper operation, the user bears the loss. Turn off the power switch, put the instrument into the portable case carefully, and put the tube into the case well.

---

## 3 Image Capture and Operation

### 3.1 Photo/Video

- ① Short press “(9) photo/video button”;
- ② The image will freeze a frame, indicating a photo has been captured and saved automatically. The saved file is named in the form of Date+No.

Such as:

20170725 001.JPEG  

---

YTD No.

- ③ Long press “(9) photo/video button” for 2 seconds, it will start to take video and the upper right corner of the screen will show the record time. After finishing it, press this button for 2 seconds again to stop the video and the file will be saved automatically.

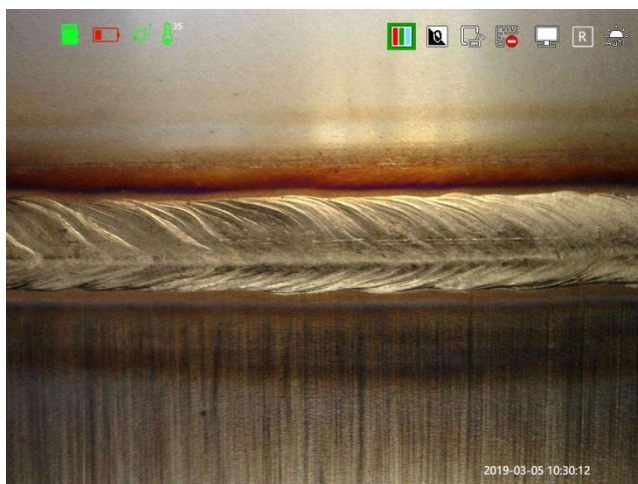

### 3.2 Temperature indication & alarm (optional, not standard configuration)



Temperature indicates on the upper left of the screen. When the testing temperature is 20°C~64°C, it indicates in green color. Orange alarm when the probe temperature is 65°C~79°C; red alarm when above 80°C. For the protection of the probe and camera, the monitor will shut off automatically.

---

### 3.3 Image special effects

In preview mode, press “(2) **OK**” button, select  , which stands for standard color mode. Press “(6) **up**” button or “(7) **down**” button, it changes to  negative film mode or  black&white mode, in cyclic switch.



### 3.4 Exposure control

Press “(2) **OK**” button, select  , which stands for exposure control mode. Press “(6) **up**” button or “(7) **down**” button, it can switch the exposure level, including 5 levels: -2/-1/0/+1/+2, in cyclic switch. According to the inspection environment, users can adjust different exposure level, in order to get clearest image.

### 3.5 Playback

In preview mode, press “(5) **playback**” button, it will change to image playback mode. Press “(6) **up**” button or “(7) **down**” button to playbacks different images. Press “(1) menu” button to pop up image delete menu, deleting images. Press “(5)” button again, it will switch to video playback mode. Press “(2)” button to playback video. Press “(2)” again to pause.

### 3.6 Measuring Function

In preview mode, press “(2) **OK**” button, select  , which stands for measuring prohibited function. Press “(6) **up**” button or “(7) **down**” button to swift to  , start measuring function. Press “(6) **up**” button or “(7) **down**” button again to close it.



---

### 3.7 Zoom in/out

In preview mode, press “(2) **OK**” button, select  , which stands for zoom in/out mode. Press “(6) **up**” button or “(7) **down**” button to adjust magnification levels, including x1、x2、x4、x8 and two modes: full screen and full image, in cyclic switch.

### 3.8 Language setting

In preview mode, press “(1) **menu**” button to enter menu dialog box. Select “**Language**” menu by pressing “(6) **up**” or “(7) **down**” button. Then press “(2) **OK**” button to pop up language option box, press “(6) **up**” or “(7) **down**” button again to select and press “(2) **OK**” to confirm.

### 3.9 Date&Time setting

In preview mode, press “(1) **menu**” button to enter menu dialog box. Select “**Date&Time**” menu by pressing “(6) **up**” or “(7) **down**” button. Then press “(2) **OK**” button to pop up date&time setting dialog box, press “(4) **return**” button to switch the format of date&time, press “(6) **up**” or “(7) **down**” button to set date&time, press “(2) **OK**” to save the setting and return to the menu bar.

### 3.10 Auto shut off

In preview mode, press “(1) **menu**” button to enter menu dialog box. Select “**Auto shut off**” menu by pressing “(6) **up**” or “(7) **down**” button. Then press “(2) **OK**” button to pop up shut off time and function option box, press “(6) **up**” or “(7) **down**” again to select shut off time and whether enable this function. Press “(2) **OK**” to save the setting.

### 3.11 Date Stamp

In preview mode, press “(1) **menu**” button to enter menu dialog box. Select “**Date Stamp**” menu by pressing “(6) **up**” or “(7) **down**” button. Then press “(2) **OK**” button to pop up format and function option box, press “(6) **up**” or “(7) **down**” again to select date stamp format and enable or turn off this function.

---

### 3.12 Formatting

In preview mode, press “(1) **menu**” button to enter menu dialog box. Select “**Format**” menu by pressing “(6) **up**” or “(7) **down**” button. Then press “(2) **OK**” button to pop up format option box, press “(6) **up**” or “(7) **down**” again to confirm whether format the files in the TF card. Press “(2) **OK**” to complete the setting.

### 3.13 Factory Reset

In preview mode, press “(1) **menu**” button to enter menu dialog box. Select “**Factory Reset**” menu by pressing “(6) **up**” or “(7) **down**” button. Then press “(2) **OK**” button to pop up factory reset option box, press “(6) **up**” or “(7) **down**” again to confirm reset all or not. Press “(2) **OK**” to complete the setting.

### 3.14 Firmware Update

The software will be continuously optimized and updated and the firmware update function will be reserved in the menu. Users can place (.bin) offered by after sale service of the factory at the top of TF card (do not place it in folders or change bin file name). Enter the setting interface, select firmware upgrade, it will be black screen. After the screen indicator light goes out, turn off the monitor, reboot and enter new system interface. Firmware update is finished.

## 4 Solution to Common Problems

<b>Problem</b>	<b>Reason</b>	<b>Solution</b>
Boot without reaction	no battery or power shortage	charge or install battery
Auto shutdown	battery power shortage	charge or change battery
Boot screen freezing	system boot failure or battery power shortage	remove the battery to re install and restart or charge
The image cannot be recorded or found	the capacity of TF card is not enough	replace TF card or delete useless files
Image stuck	system stuck	shutdown and restart or reset



