

T3000



EN

PRACTICE HANDBOOK
MULTIFUNCTION
MEASURING
METER

 **TROTEC**
AT WORK.

Foreword

Dear customer,

With the purchase of the T3000 digital multi-function measurement device you have chosen a measurement system that is innovative, precise and easy to operate. A good decision, for which we would like to thank you!

In order that you can use the potential of this versatile measurement device quickly and comprehensively, we have designed this practice handbook for you.

Even if you possess the most up-to-date version of our practice handbook you will not find an detailed description of use for every sensor that is available. Because of the growing number of available sensors this would go beyond the limits of any practice handbook. Instead for each series of sensors we have selected the sensor that is most often used as an example.

The T3000 takes the form of a modular measurement system, designed from practical experience for practical use. In many situations the combination of different sensors and measuring methods can produce innovative problemsolving strategies and diagnostic procedures.

For this reason we would also be very pleased to hear about your own experience in practice.

Please tell us about any procedures and combinations of measurements that you use successfully in your own work, and which up to now have not appeared in the practice handbook. Perhaps you will then find "your method" in the next update of the handbook!

Now we would like to wish you much enjoyment and inspiration as you read this handbook, and in the application of your T3000 in practice.

| | |
|--|----------|
| 1. Introduction | 1 – 01 |
| 2. Measurement of temperature and relative air humidity | 2.1 – 01 |
| 2.1 Fundamentals regarding temperature and relative air humidity | 2.1 – 01 |
| 2.2 Measurement of air temperature and air humidity | 2.2 – 01 |
| 2.2.1 <i>Measurement principles</i> | 2.2 – 01 |
| 2.2.2 <i>The TS 210 SDI sensor for climatic measurements – operation and measurement procedure</i> | 2.2 – 01 |
| 2.2.3 <i>Interference effects and instructions to be followed</i> | 2.3 – 01 |
| 2.3 Temperature measurement with Thermal sensors | 2.3 – 01 |
| 2.3.1 <i>Measurement principle</i> | 2.3 – 01 |
| 2.3.2 <i>Sensors for temperature measurement – operation and measurement procedure</i> | 2.3 – 03 |
| 3. Wood – determination of moisture content | 3.1 – 01 |
| 3.1 Fundamentals regarding moisture content in wood and characteristic parameters | 3.1 – 01 |
| 3.1.1 <i>Definition of moisture content in wood</i> | 3.1 – 01 |
| 3.1.2 <i>Influence of moisture content on the properties of wood</i> | 3.1 – 02 |
| 3.1.3 <i>Assessment of the wood moisture content by means of some characteristic parameters</i> | 3.1 – 05 |
| 3.2 Wood moisture content measurement – resistance principle | 3.2 – 01 |
| 3.2.1 <i>Measurement principle</i> | 3.2 – 02 |
| 3.2.2 <i>Electrodes for wood moisture content measurement – operation and measurement procedure</i> | 3.2 – 06 |
| 3.2.3 <i>Measurement of the wood moisture content in cut timber</i> | 3.2 – 09 |
| 3.2.4 <i>Interference effects and instructions to be followed for resistance measurements</i> | 3.2 – 11 |
| 3.3 Wood moisture content measurement – capacitive method | 3.3 – 01 |
| 3.3.1 <i>Measurement principle</i> | 3.3 – 01 |
| 3.3.2 <i>The TS 660 SDI sensor for wood moisture content measurement – measurement procedure and operation</i> | 3.3 – 01 |
| 3.3.3 <i>Interference effects and instructions to be followed for the capacitive measurement methods</i> | 3.3 – 03 |
| 3.3.4 <i>Comparison values for the assessment of the measured capacitive values</i> | 3.3 – 03 |
| 4. Mineral building materials – determination of moisture content | 4.1 – 01 |
| 4.1 Fundamentals regarding moisture content in building materials and characteristic parameters | 4.1 – 01 |
| 4.1.1 <i>Definition and options for determination of building material moisture content</i> | 4.1 – 01 |
| 4.1.2 <i>Mechanisms for moisture transport in mineral building materials</i> | 4.1 – 02 |
| 4.1.3 <i>Assessment of the building material moisture content with some limiting values</i> | 4.1 – 05 |
| 4.2 Building material moisture content measurement – resistance principle | 4.2 – 01 |
| 4.2.1 <i>Measurement principle</i> | 4.2 – 01 |
| 4.2.2 <i>Electrodes for building material moisture content measurement – operation and measurement procedure</i> | 4.2 – 02 |

| | | |
|------------|--|-----------------|
| 4.2.3 | <i>Compilation of the most important comparison values for assessment of measured results</i> | 4.2 – 05 |
| 4.2.4 | <i>Depth measurements on covered layers of building material</i> | 4.2 – 06 |
| 4.2.5 | <i>Comparative values for the assessment of water-damaged areas</i> | 4.2 – 09 |
| 4.2.6 | <i>Interference effects and instructions to be followed for resistance measurements</i> | 4.2 – 09 |
| 4.2.6.1 | <i>Interference effects caused by electrically conducting salts in the building material</i> | 4.2 – 10 |
| 4.2.6.2 | <i>Interference effects caused by electrically conducting materials</i> | 4.2 – 10 |
| 4.3 | <i>Building material moisture content measurement – capacitive method</i> | 4.3 – 01 |
| 4.3.1 | <i>Measurement principle</i> | 4.3 – 01 |
| 4.3.2 | <i>The TS 660 SDI sensor for building material moisture content measurement – measurement procedure and operation</i> | 4.3 – 02 |
| 4.3.3 | <i>Interference effects and instructions to be followed for the capacitive measurement method</i> | 4.3 – 04 |
| 4.3.4 | <i>Compilation of the most important comparison values for assessment of measured results</i> | 4.3 – 04 |
| 4.4 | <i>Building material moisture content measurement – hygrometric method</i> | 4.4 – 01 |
| 4.4.1 | <i>Measurement principle</i> | 4.4 – 01 |
| 4.4.2 | <i>Hygrometric building material moisture measurements</i> | 4.4 – 01 |
| 4.4.2.1 | <i>Moisture content measurement in screed</i> | 4.4 – 01 |
| 4.4.2.2 | <i>Moisture content measurement in concrete</i> | 4.4 – 03 |
| 4.4.2.3 | <i>Moisture content measurement in tiled wall or floor areas</i> | 4.4 – 04 |
| 4.4.2.4 | <i>Moisture content measurement in combination with CM measurements</i> | 4.4 – 05 |
| 4.4.3 | <i>Values obtained from experience in the assessment of building material moisture content with regard to readiness for covering</i> | 4.4 – 06 |
| 4.4.4 | <i>Interference effects and instructions to be followed for the hygrometric method</i> | 4.4 – 07 |
| 4.5 | <i>Building material moisture content measurement – microwave method</i> | 4.5 – 01 |
| 4.5.1 | <i>Measurement principle</i> | 4.5 – 01 |
| 4.5.2 | <i>Moisture content measurement with the TS 610 SDI microwave sensor</i> | 4.5 – 02 |
| 4.5.3 | <i>Interference effects and instructions to be followed for the microwave method</i> | 4.5 – 03 |
| 4.5.4 | <i>Combined use of the TS 660 SDI und TS 610 SDI in building diagnostics</i> | 4.5 – 04 |
| 4.5.4.1 | <i>Causal analysis of mould growth due to condensation moisture content</i> | 4.5 – 04 |
| 4.5.4.2 | <i>Rising damp in brickwork and stonework / hygroscopic occurrences of damp caused by the presence of salts</i> | 4.5 – 05 |
| 4.5.4.3 | <i>Location of failures in sealing systems and leakages</i> | 4.5 – 06 |
| 5. | <i>Measurement of air flow velocity</i> | 5 – 01 |
| 6. | <i>Calibration service</i> | 6 – 01 |
| 7. | <i>Summary</i> | 7 – 01 |
| 8. | <i>References</i> | 7 – 01 |

1. Introduction

In many areas of industry and the building trades it is becoming ever more important to be familiar with interior climatic conditions and the material properties for specific raw or processed materials. Amongst other properties, the material moisture content is an important parameter that can determine the quality of a material or a building component.

For example, the state of the moisture content, both in the material that is being applied, and in the substrate to which it is being applied, must be known in order to guarantee an enduring fitness for purpose.

When the T3000 is used professionally it is possible to obtain an on-site overview of the status of the material. This takes place in the form of rapid, non-destructive (or almost non-destructive) measurements.

Since not just our own experience has shown that for professional use of a measurement device it is always worth being familiar with the physical and technical background, we have placed particular emphasis on use of the operating instructions and the practice handbook. In these two documents we have brought together the most important pieces of information for the practical use of the T3000.

The operating instructions that accompany the measurement device fully describe its intended purpose and are suitable as a quick introduction for experienced users who are already familiar with the appropriate physical and technical background to the respective measuring methods. You will also find the most up-to-date version of the operating instructions (see version number on the first page) in the download area of www.trotec.com. The table of wood species can also be found there.

The present handbook, which contains extensive background knowledge for professional practical use, is intended for beginners or as an aide-memoire for advanced users. Therefore before any study of the handbook the operating instructions should be read first. Some contexts, such as, for example, those relating to actual measurement procedures, can only be carried out together with the operating instructions.

As for all other measurement device the following basic principle applies: "every measurement device is only as good as its user".

Only correct operation enables correct interpretation and professional classification of the values measured. Therefore in the present handbook you will find, alongside the basics of the physical principles of measurement, also background material relevant to the building industry with fundamental legislation as well as international limits and guidelines. These data should be understood as an introduction into the problem, since this compilation cannot claim to be complete. What is absolutely essential is a familiarity with the current limits that are in force for specific countries and the generally recognised regulations of the technology. These are part of the individual responsibilities that must remain with the user of the unit.

For the assessment and interpretation of the measured values determined it is essential to be familiar with the accuracy of the method that is being used. Amongst other factors, this includes an understanding of whether the values measured can be related to a direct or an indirect measurement method.

Direct versus indirect measurement methods

The kiln-drying method and the CM method, amongst others, are classified as direct measurement methods. Both methods feature separation of the water from the solid material. [1]

Here the kiln-drying method is the most accurate. The material sample extracted is weighed, fully dried, and then weighed again. The difference in weight between the moist and the dry sample then corresponds to the mass of water contained in the material. The kiln-drying method exhibits the most reproducible measured data of all the measurement methods known and is internationally recognised accordingly. [2]

However **four** important **practical disadvantages** are linked with the method. **Firstly** the measurements cannot be carried out on the building site, **secondly** the material is damaged, **thirdly** conclusions can only be drawn after several days, and **fourthly** a measurement cannot be repeated at the same location.

In the case of indirect measurement methods the moisture content is determined via the properties and effects of the water. The resistance, capacitive, hygrometric and microwave methods are based on measurement principles that lead to largely non-destructive measurement results.

In the case of the resistance method the resistance or conductivity of the material is measured, which alters as a function of the water content in the building material.

In the case of the capacitive and microwave methods the dielectric property alters as a function of the water content in the building material. The dielectric constant is, in the same way as electrical resistance, a variable property of materials. It increases or decreases as a function of the moisture content in the material.

The principle of the hygrometric measurement method is the property that mineral building materials interact with the ambient air. If the relative humidity of the ambient air increases then the moisture content of the building material increases also. After a certain period of time a state of moisture equilibrium is attained, in which the porous building material exhibits a certain quantity of water.

Regarding the accuracy of both the indirect measuring methods, it should be noted that the measurement curves implemented for the resistance and capacitive methods have been researched by the Institute for Building Research at the RWTH Aachen University. Here calibration measurements, in combination with the kiln-drying method, have been carried out on selected building materials. [18]

Furthermore the Institute has checked the ergonomics of the device as well as its suitability for on-site use. The pertinent results have been taken into account in the practice handbook.

Classification of the building materials

The structural and other materials used in construction can be divided into two main groups. The first group features inorganic materials and the second group features organic materials (see Table 1).

In turn the inorganic materials divide into the two sub-groups of mineral materials and metallic materials.

The handbook is structured in accordance with this classification. It is mainly concerned with the determination of moisture content in the materials named.

Since the moisture content of building materials is always influenced by the ambient conditions, Chapter 2 is dedicated to this topic. This deals in particular with temperature and humidity measurements, amongst others.

In Chapter 4 this knowledge is then applied to the measurement of moisture content in the material.

Chapter 3 investigates the measurement of moisture content in organic materials. The focus of attention here is on solid timbers and wood-based materials.

Chapter 4 is concerned with the determination of moisture content in porous mineral materials. The organic insulating materials (e.g. polystyrene slabs) are also dealt with here, since they usually form part of a multi-layer mineral building component.

Included in the range of sensors is also an anemometer sensor, with which the flow velocity of the air can be determined. This topic is dealt with in Chapter 5.

| Inorganic building materials | | Organic building materials |
|---|--|--|
| <i>mineral</i> | <i>metallic</i> | |
| <ul style="list-style-type: none"> • Mortar • Concrete • Natural building stone • Artificial building stone • Ceramic materials and vitreous enamel • Glass | <ul style="list-style-type: none"> • Ferrous materials • Structural steel • Concrete reinforcement steel • Tensile steel • Non-ferrous metals | <ul style="list-style-type: none"> • Wood and wood-based materials • Plastics • Concrete additives • Bitumen |

Table 1: Classification of building materials (from [7])

2. Measurement of temperature and relative air humidity

For the assessment of damage caused by dampness in building materials or building components it is not usually sufficient to determine just the moisture content in the building material.

Surface temperatures of the building components, air temperature and air humidity can provide decisive additional information in any total assessment, since the building material and the ambient conditions are always interacting with each other.

In connection with these three measurement parameters cited the accompanying determination of the dew point temperature is often of particular significance.

When used with the correct sensors, the T3000 enables rapid measurement of temperature and air humidity (absolute air humidity, relative air humidity) together with the determination of the dew point.

2.1 Fundamentals regarding temperature and relative air humidity

In the ambient air there is always present a certain amount of gaseous water vapour that is invisible to the naked eye. Depending on the temperature, air is able to absorb a very well-defined quantity of water. The warmer the air, the

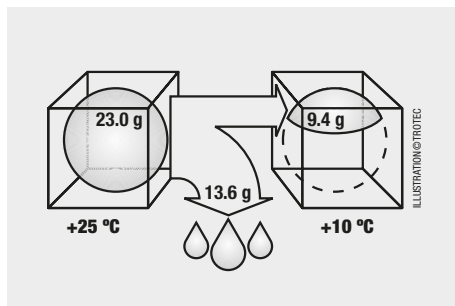

Figure 1: Water vapour content of the air [8]

more water that it can absorb. If the maximum possible quantity of water at a given temperature is exceeded by a lowering of the temperature (if, for example, a bathroom window is opened in winter after a shower) water is precipitated in the form of small droplets and becomes visible to the human eye in the form of a mist (see Figure 1).

The concentration of water vapour in the air is defined in terms of the absolute air humidity. It describes the ratio of the water content per unit volume of air and is given in terms of grams of water per cubic metre of air (see formula for “absolute air humidity”). [2]

Analogous to the concept of absolute humidity is the concept of relative humidity w . It is defined as a percentage and describes the state of saturation of the air (see formula for “relative air humidity”).

$$\text{Absolute air humidity} = \frac{\text{mass of water vapour at a particular temperature [g]}}{\text{volume of air at the same temperature [m}^3\text{]}}$$

$$\text{Relative air humidity } r.h. = \frac{\text{actual water vapour concentration at a particular temperature}}{\text{maximum water vapour concentration at the same temperature}}$$

| Type of space | rel. Humidity | Temperature |
|---------------------------------------|---------------|---------------|
| Living rooms, offices, working spaces | 50 % | at 19 - 24 °C |
| Library | 40 - 50 % | at 22 °C |
| Picture gallery | 45 - 55 % | at 20 °C |
| Antiques | 45 - 50 % | at 20 - 24 °C |
| Books (in storage) | 40 - 50 % | at 15 - 20 °C |

Table 2: Selected required humidity and temperature values for spaces

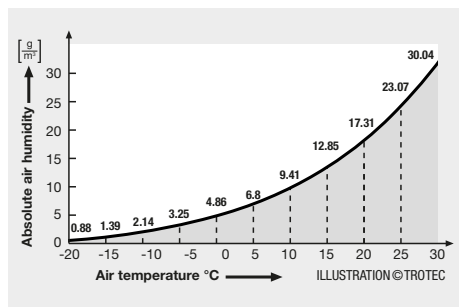

Figure 2: Saturation curve

The saturation curve defines the maximum level of moisture that can be absorbed from the air. Levels of water vapour content above the saturation curve are not possible. [2]

In conjunction with the saturation level and the concentration of water vapour the temperature dependence must be considered in more detail. If moist air is cooled down quickly, water precipitates out on the “cold spot”. The reason for this is that “cold” air can store less water vapour than “warm” air.

With continuous cooling the relative air humidity continues to increase until the air is finally saturated ($w = 100\%$, Figure 2).

The temperature at which this state of saturation is reached is called the dew point temperature, or sometimes the dew point. As a rule the dew point must be determined by calculation or from a table (see Table 3).

Conversions between the three parameters of dew point temperature, relative and absolute humidity can be determined from the diagram shown in Figure 3.

The T3000 offers the great advantage that by means of an appropriate choice of unit the dew point temperature, relative air humidity or absolute air humidity can be displayed directly in field 2 of the sensor.

| DT °C | Dew point temperature DT in °C at a relative air humidity φ of | | | | | | | | | | | | | | |
|----------|--|------|------|------|------|------|------|------|------|------|------|------|------|------|--|
| | 30 % | 35 % | 40 % | 45 % | 50 % | 55 % | 60 % | 65 % | 70 % | 75 % | 80 % | 85 % | 90 % | 95 % | |
| 30 | 10.5 | 12.9 | 14.9 | 16.8 | 18.4 | 20 | 21.4 | 22.7 | 23.9 | 25.1 | 26.2 | 27.2 | 28.2 | 29.1 | |
| 29 | 9.7 | 12 | 14 | 15.9 | 17.5 | 19 | 20.4 | 21.7 | 23 | 24.1 | 25.2 | 26.2 | 27.2 | 28.1 | |
| 28 | 8.8 | 11.1 | 13.1 | 15 | 16.6 | 18.1 | 19.5 | 20.8 | 22 | 23.2 | 24.2 | 25.2 | 26.2 | 27.1 | |
| 27 | 8 | 10.2 | 12.2 | 14.1 | 15.7 | 17.2 | 18.6 | 19.9 | 21.1 | 22.2 | 23.3 | 24.3 | 25.2 | 26.1 | |
| 26 | 7.1 | 9.4 | 11.4 | 13.2 | 14.8 | 16.3 | 17.6 | 18.9 | 20.1 | 21.2 | 22.3 | 23.3 | 24.2 | 25.1 | |
| 25 | 6.2 | 8.5 | 10.5 | 12.2 | 13.9 | 15.3 | 16.7 | 18 | 19.1 | 20.3 | 21.3 | 22.3 | 23.2 | 24.1 | |
| 24 | 5.4 | 7.6 | 9.6 | 11.3 | 12.9 | 14.4 | 15.8 | 17 | 18.2 | 19.3 | 20.3 | 21.3 | 22.3 | 23.1 | |
| 23 | 4.5 | 6.7 | 8.7 | 10.4 | 12 | 13.5 | 14.8 | 16.1 | 17.2 | 18.3 | 19.4 | 20.3 | 21.3 | 22.2 | |
| 22 | 3.6 | 5.9 | 7.8 | 9.5 | 11.1 | 12.5 | 13.9 | 15.1 | 16.3 | 17.4 | 18.4 | 19.4 | 20.3 | 21.2 | |
| 21 | 2.8 | 5 | 6.9 | 8.6 | 10.2 | 11.6 | 12.9 | 14.2 | 15.3 | 16.4 | 17.4 | 18.4 | 19.3 | 20.2 | |
| 20 | 1.9 | 4.1 | 6 | 7.7 | 9.3 | 10.7 | 12 | 13.2 | 14.4 | 15.4 | 16.4 | 17.4 | 18.3 | 19.2 | |
| 19 | 1 | 3.2 | 5.1 | 6.8 | 8.3 | 9.8 | 11.1 | 12.3 | 13.4 | 14.5 | 15.5 | 16.4 | 17.3 | 18.2 | |
| 18 | 0.2 | 2.3 | 4.2 | 5.9 | 7.4 | 8.8 | 10.1 | 11.3 | 12.5 | 13.5 | 14.5 | 15.4 | 16.3 | 17.2 | |
| 17 | -0.6 | 1.4 | 3.3 | 5 | 6.5 | 7.9 | 9.2 | 10.4 | 11.5 | 12.5 | 13.5 | 14.5 | 15.3 | 16.2 | |
| 16 | -1.4 | 0.5 | 2.4 | 4.1 | 5.6 | 7 | 8.2 | 9.4 | 10.5 | 11.6 | 12.6 | 13.5 | 14.4 | 15.2 | |
| 15 | -2.2 | -0.3 | 1.5 | 3.2 | 4.7 | 6.1 | 7.3 | 8.5 | 9.6 | 10.6 | 11.6 | 12.5 | 13.4 | 14.2 | |
| 14 | -2.9 | -1 | 0.6 | 2.3 | 3.7 | 5.1 | 6.4 | 7.5 | 8.6 | 9.6 | 10.6 | 11.5 | 12.4 | 13.2 | |
| 13 | -3.7 | -1.9 | -0.1 | 1.3 | 2.8 | 4.2 | 5.5 | 6.6 | 7.7 | 8.7 | 9.6 | 10.5 | 11.4 | 12.2 | |
| 12 | -4.5 | -2.6 | -1 | 0.4 | 1.9 | 3.2 | 4.5 | 5.7 | 6.7 | 7.7 | 8.7 | 9.6 | 10.4 | 11.2 | |
| 11 | -5.2 | -3.4 | -1.8 | -0.4 | 1 | 2.3 | 3.5 | 4.7 | 5.8 | 6.7 | 7.7 | 8.6 | 9.4 | 10.2 | |
| 10 | -6 | -4.2 | -2.6 | -1.2 | 0.1 | 1.4 | 2.6 | 3.7 | 4.8 | 5.8 | 6.7 | 7.6 | 8.4 | 9.2 | |

Table 3: Dew point temperature DT as a function of temperature T and relative humidity φ [6]

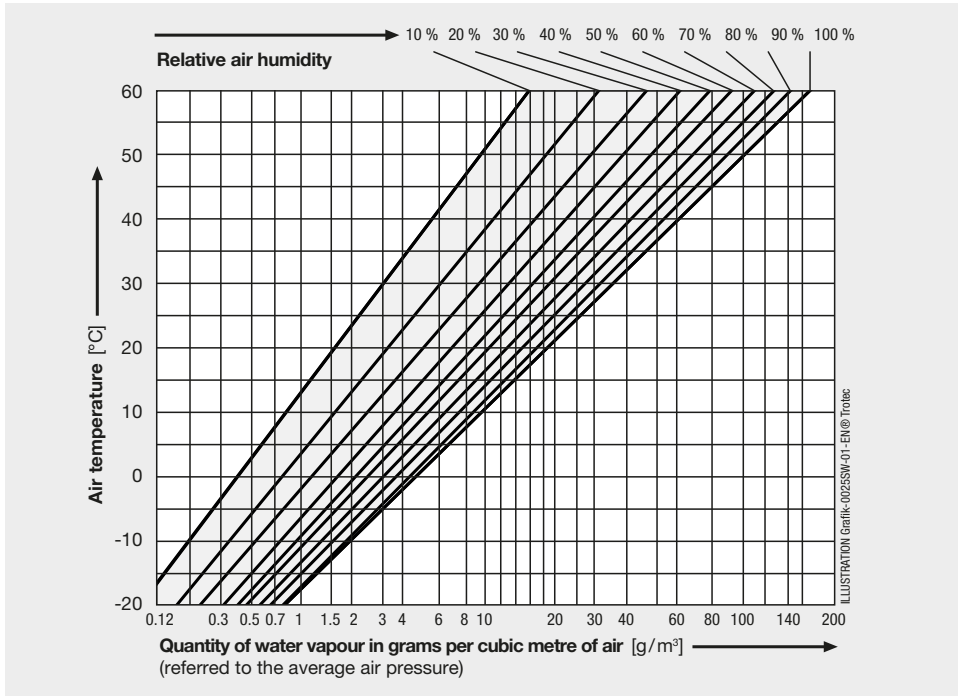
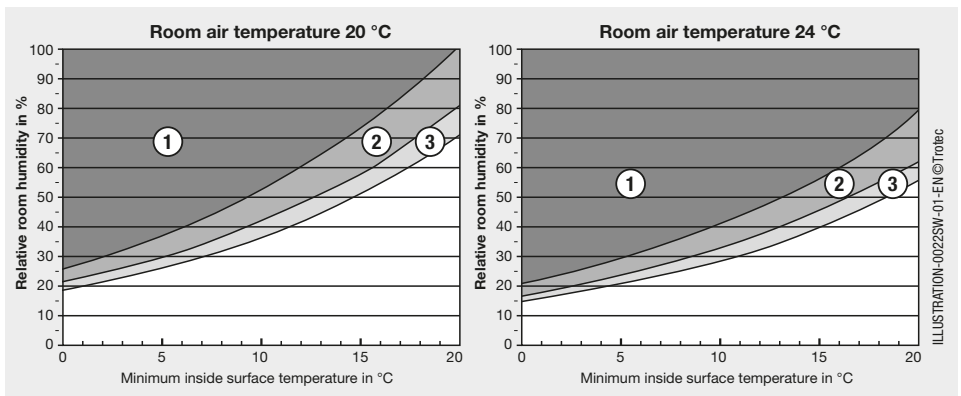

Figure 3: Diagram of the water vapour content of air [2]

In Figure 4 a further problem in building diagnostics is identified: condensation and mould formation in buildings. Their appearance is determined to a considerable extent

by the climatic relationship between room air temperature and relative air humidity.



① Formation of condensation and mould, ② Formation of mould, ③ Limit range for formation of mould

Figure 4: Relative air humidity limits for formation of condensation or mould in buildings depending on the minimum inside surface temperatures in the vicinity of vulnerable areas (thermal bridges, etc).

2.2 Measurement of air temperature and air humidity

For determination of the two measurement quantities, air temperature and air humidity, only one SDI sensor is required. Here the standard sensor for most fields of application is the TS 210 SDI climatic sensor. For this reason the following Section 2.2.2 relates to the example of this sensor in particular.

If measurements are to be carried out at very high temperatures, it is necessary to use the TS 230 SDI sensor. This high temperature sensor allows measurements in ranges up to +180 °C.

For special applications in which a particularly narrow sensor head is required, in particular for hygrometric metric measurements in drilled holes and areas that are difficult to access, the TS 250 SDI climatic sensor with a diameter of 4 mm and a length of 250 mm is also available.

In the measurement head of all three sensors measurements are made using two different measurement principles. The resistance principle is used to register air temperature and the capacitive principle is used to determine relative air humidity.

Using digital technology it is now possible to define relative humidity (r.h.), absolute humidity (g/m³), the specific humidity (mixing ratio in g / kg dry air), air temperature (°C, °F) and the dew point temperature (dp °C, dp °F).

2.2.1 Measurement principles

The temperature measurement is performed with a so-called NTC sensor (Negative Temperature Coefficient) that changes its electrical resistance as a function of temperature.

In parallel with the temperature measurement the air humidity is determined with a capacitor. The moisture-sensitive capacitor consists of two flat electrodes between which is located a layer of electrically insulating, hygroscopic plastic (the dielectric). This dielectric can absorb water that is located in the air. With increasing air humidity the capacitance of the moisture-sensitive capacitor also increases.

2.2.2 The TS 210 SDI sensor for climatic measurements – operation and measurement procedure

The climatic sensor uses a robust plastic probe with a replaceable filter cap at the tip. The sensor is designed exclusively for the measurement of air temperature and relative air humidity. Accordingly the tip must not be immersed in a fluid medium such as e.g. water.

In operation the following points are to be noted:

1. For precise measurements the sensor and the measurement device should first be acclimatised to the ambient climatic conditions. As a rule a waiting time of about 10 to 15 minutes is sufficient. This is particularly true for the colder seasons of the year, e.g. if one has transported the measurement case in a cold car and then wishes to undertake measurements in a heated room immediately. Acclimatisation can take place while the device is switched off.
2. A severe accumulation of dust/dirt can impair the measured results. Under these conditions use the stainless steel sinter filter (1) that is available as an optional exchangeable protective cap. Here it should be noted that this filter leads to delay in the display of measured values as a result of its design. This must be taken into account when determining measured values.



Measurement procedure

In the measurement of temperature and humidity the following steps are to be performed in the basic setting that is automatically active.

1. Before the actual measurement procedure attention has to be paid to the operational points described above (contamination with dust/dirt and acclimatisation).
2. Connect the sensor with the connection cable TC 30 SDI to the T3000.
3. Switch on the T3000.
4. Check the setting of the sensor ID of the T3000. In the event that this is not set, please select.
5. Read the air temperature (°C, °F) and the relative humidity (RH) in the respective sensor field.

As an alternative to this basic setting, the absolute humidity, dew point and mixing ratio can also be displayed (see operating manual).

2.2.3 Interference effects and instructions to be followed

From the measurement principles described above the following instructions emerge:

- Take care that the sensor unit is not damaged by environmental effects and/or mechanically. This can occur for instance as a result of direct contact of the humidity sensor with the fingers.

It can also occur as a result of direct contact of the sensor with adhesive materials and measurements taken in an atmospheric environment that is loaded (with e.g. oil vapours, vapours containing solvents, air exhibiting a generally high level of contaminants).

- Slight flows of air, such as are produced by an open window, for example, can affect the measured value displayed. Correspondingly there can be fluctuations in measured values if the measurements are being performed in a flow of air.
- The filter cap should be cleaned at regular intervals since the mesh can otherwise become clogged. The cap can be cleaned with compressed air;

here the mesh must be carefully blown clear from the inside to the outside.

- For the case in which high requirements are placed on the accuracy of the air humidity measurements over the long term, a single-point calibration is recommended at intervals of one year.

You will find further information on the single-point calibration (r.h.) in Chapter 6 of this handbook and in the operating instructions.

2.3 Temperature measurement with Thermal sensors

The electrical temperature measurement can take place in accordance with two different measurement principles. One is the thermocouple principle and the other is the resistance principle.

Thermocouples offer a **large measurement range** in conjunction with a **rapid response time**. In contrast the **resistance sensors** (Pt100) are **slower**, but have the advantage that they provide more **precise temperature** readings.

The currently compatible sensor technology for the T3000 consists exclusively of sensors to thermocouple basis.

2.3.1 Measurement principle

The temperature measurement using thermistor (NTC) occurs at a metal sensor tip about the change in electrical resistance. The higher the temperature of the sensor, the lower the electrical resistance.

The thermistors are passive sensors. They have a negative temperature coefficient (NTC negative temperature coefficient), making her material-specific electrical resistance decrease with increasing temperature.

To minimize, the measuring result possibly affecting self-heating of the NTC sensor during the measurement, it is operated with a low current.

The starting material of commercially sold NTCs, also known as "hot wire" is typically a metal oxide (z.B. Mn_3O_4 , TiO_2 , CuO , Cu_2O , PbO , NiO , CoC , Co_3O_4 , Fe_2O_3 , or other metal oxides).

The term “thermistor” is, due to the good electrical conductivity of these sensors, used at higher temperatures.

With regard to their doping thermistor are divided into three groups generally:

- p-type semiconductor
- n-type semiconductor, and
- Ion conductor.

The advantage of NTCs against resistance thermometers such as PT100 is its higher sensitivity and greater resistance range. The specific resistance of these sensors behaves anti-proportional to the product of the mobility and the concentration of the dominant charge carriers.

Function and accuracy of the NTC are therefore largely dependent on the state of the atomic microstructure of ceramic materials.

To customize thermistor with reproducible properties, in first place is the control of grain size, the grain boundary properties and voids in the microstructure and the prevention of contamination during production.

2.3.2 Sensors for temperature measurement – operation and measurement procedure

Temperature measurement with NTC sensors can be carried out with different types of buildings. Currently there is 1 sensor that has been developed for measuring individual use.

TS 131/150 ① – Surface temperature sensor

This sensor accuracy class B has a 150 mm long metal probe with a flat head (diameter 5 mm) to detect the surface temperature. The sensor should only be used for temperature measurement on smooth surfaces. Should this be rough, the contact point should be pre-treated with a commercial silicone thermal compound.

The sensor is particularly suitable for use in temperature compensation when determining the moisture content of wood.

The design enables the surface temperature of the material being measured to be particularly accurately determined (see chapter on the measurement of wood moisture content).

Measurement range -50 °C ... +400 °C.

In operation the following points are to be noted:

1. Press the sensor head gently onto the measured object and make sure that a planar contact occurs. An air gap would distort the result.
2. Reading of the measured value – depending on the type of material being measured – by about 5 to 25 seconds response time.

Measurement procedure

For each temperature measurement the following steps are then to be performed:

1. Select sensor depending upon the measurement task and the field of application.
2. Perform the operation and measurement preparations appropriate to the sensors selected.
3. Connect the sensor with the connection cable TC 30 SDI to the T3000.
4. Switch on the T3000.
5. Check the setting of the sensor ID of the T3000. If this is not set, select accordingly.
6. Between sensor and the medium being measured a temperature equalisation must first of all take place. Here the sensor must first of all “take up” the temperature of the material being measured before a precise measurement can take place (response time).
7. Read the temperature of the T3000 – according to the response (see user manual) of the sensor used.

Designs:

Surface sensor with flat measuring tip (E)
for measurements at extremely high temperatures.



3. Wood – determination of moisture content

3.1 Fundamentals regarding moisture content in wood and characteristic parameters

At the present time the most accurate and most reliable method for determining moisture content in wood is the kiln-drying method. Determination takes place on test samples by weighing, drying down to a moisture content of 0 % and weighing once again (DIN EN 13183-1).

Since this method, as already stated, is not non-destructive and is time-consuming, the moisture content can be determined more simply and at the same time almost entirely non-destructively by means of the resistance method.

In this regard the T3000 fulfils the technical prerequisites for obtaining qualitatively meaningful statements regarding the measurement of moisture content in wood. This has been confirmed by research projects undertaken by internationally recognised Institutes.

In what follows the most important terms and parameters regarding moisture content in wood are presented and described.

3.1.1 Definition of moisture content in wood

Wood moisture content “u”

The wood moisture content “u” is defined as a mass percentage and indicates the ratio between the mass of water contained in the wood and the mass of the kiln-dried wood material.

The moisture content in the wood is determined via the kiln-drying method. For this purpose a wood sample is weighed, completely dried at 105 °C and then weighed a second time. By subtracting the dry weight from the moist weight one obtains the weight of the water that was previously contained in the sample. [2]

Wood is said to be “hygroscopic”. It possesses the property of being able to absorb moisture from the air (swelling) and is also able to give it up again (shrinkage). The moisture content of the wood is dependent on the type and duration of storage, the moisture in the ambient air and the section dimensions.

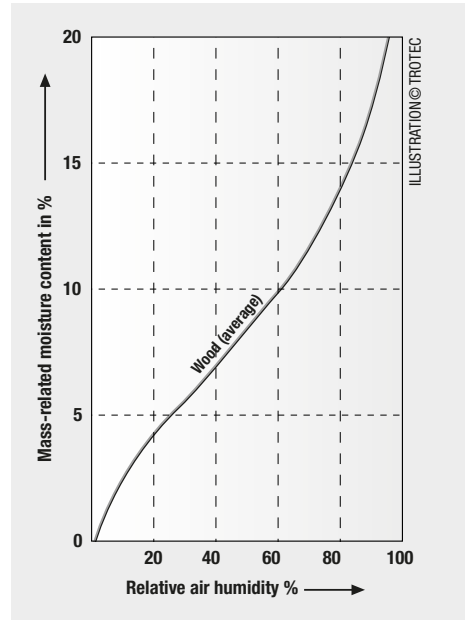

Figure 6: Sorption isotherm for wood [19]

As a function of the relative air humidity at a constant temperature a moisture equilibrium is established that can be represented graphically in the form of so-called sorption isotherms (see Figure 6).

For example with a natural drying process (in the open air and roofed over) a moisture content “u” of about 15 % is established in one to four years depending on the species of wood [12]. This corresponds to an average relative air humidity over the year of 80 %.

$$\text{Wood moisture content "u" = } \frac{\text{Mass of moist wood - mass of kiln-dried wood}}{\text{Mass of kiln-dried wood}} \cdot 100 [\%]$$

3.1.2 Influence of moisture content on the properties of wood

With reference to the dimensional stability of the wood the swelling and shrinkage are of significance. These properties depend strongly upon the fibre saturation point.

Fibre saturation point

Moisture appears in a piece of wood in two different forms. On the one hand it appears as water held in the material of the cell wall, and on the other hand as free water in the cell cavities in the wood (see Figure 7). During the drying process the free water first of all evaporates out of the cell cavities. The point at which the wood no longer contains any free water is known as the fibre saturation point. It lies between 23 and 35 M-% depending upon the species of wood. [3]

Swelling and shrinkage

During a natural or artificial drying process from green wood to the kiln-dried state the wood passes through four characteristic states.

1. In freshly-felled timber the cell cavities and the cell walls are filled with water. Here the mass of the water can be several times that of the wood material. A freshly-felled spruce can for example exhibit a moisture content of up to 150 % [3]. (1)
2. In the first drying phase the free water evaporates. Depending upon the ambient conditions and the species of wood this can take place over a varying period. When

the free water has completely evaporated the fibre saturation point is reached. (2) and (3)

3. In the second drying phase the water held in the cell walls evaporates. The volume of the wood decreases, a phenomenon known as **shrinkage**. (4)
4. Further drying of the wood down to a moisture content of 0 % can only be achieved using an artificial drying process, since the ambient air always possesses a relative humidity. This state can only be achieved by means of the kiln-drying process. (5)

Within the moisture content range between 0 % and about 30 % the volume can alter, not only as a result of the shrinkage process. If the wood - in a reverse of the shrinkage process - takes water out of the air, then this is first of all held in the cell walls. The volume of the wood increases, a phenomenon known as **swelling**. (4)

The swelling process however only progresses up to the point at which the fibre saturation point is reached (3). Above the fibre saturation point the volume no longer alters since the water that is taken in now collects in the cell cavities.

Correspondingly the volume of the wood only alters by swelling and shrinkage within the moisture content limits between 0 % and about 30 %. The shrinkage and swelling dimensions are dependent upon the species and density of the wood and on the direction of the alteration in volume. Wood reacts most strongly in the direction of the annual

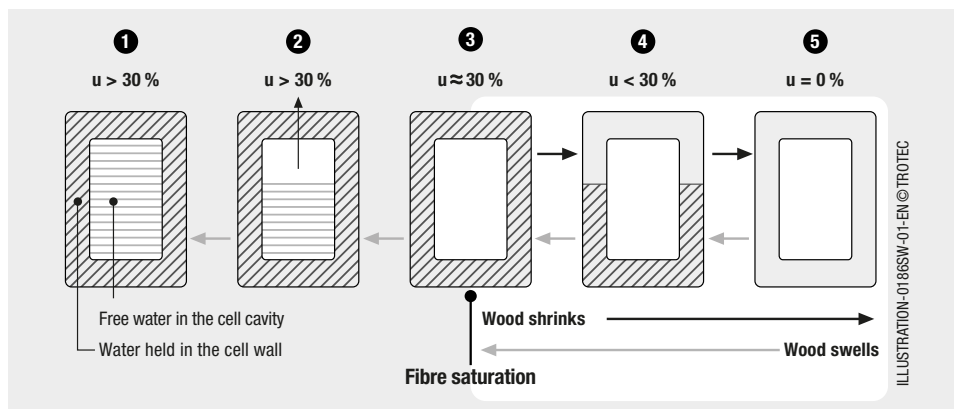

Figure 7: Water release and water absorption in the wood cell [12]

rings (about 10 %), half as much in the direction of the medullary rays (about 5 %), and much less in the direction of the fibres (about 0.1 %). All three types of deformations occur together and are superimposed. [3]

Table 6 gives the total shrinkage dimensions β (β_t = tangential, β_r = radial, β_v = vertical) and differential shrinkage/swelling dimensions q (q_t = tangential, q_r = radial, q_v = vertical) for selected species of woods in %.

Since the dimensional stability of the wood is crucial when it is being processed, this explains the particular necessity for determining the moisture content in the wood. For final processing the wood must be brought into a moisture content state that corresponds as exactly as possible to the ambient conditions in which the finished product will later be used.

This state can be defined in terms of the equilibrium moisture content u_{gl} .

| Species of wood | β_t | β_r | β_v | q_t | q_r | q_v |
|-------------------|------------------|-----------------|--------------------|-------|-------|-------------|
| Abachi | 4.6...5.6...6.7 | 2.2...3.3...4.2 | 6.9...9.1...11.5 | 0.22 | 0.11 | 0.19...0.32 |
| Afromosia | 6.0...7.0 | 3.0...3.5 | 9.4...10.0 | 0.32 | 0.18 | 0.41...0.43 |
| Alder | 7.7...9.3 | 4.4...4.8 | 12.6...14.2 | 0.27 | 0.16 | 0.15...0.30 |
| Ash | 8.0...8.4 | 4.6...5.0 | 12.8...13.6 | 0.38 | 0.21 | 0.43...0.45 |
| Birch | ~ 7.8 | ~ 5.3 | 13.7...14.2 | 0.41 | 0.29 | ~ 0.23 |
| Bongossi | 8.3...8.7...10.8 | 6.7...7.4...9.2 | 15.2...16.4...21.0 | 0.4 | 0.31 | 0.51...0.70 |
| Cherry | 6.5...8.7 | 3.5...5.0 | 13.7...14.0 | 0.28 | 0.17 | ~ 0.46 |
| Doussie | 3.6...4.4 | 2.2...3.3 | 6.4...7.7 | 0.22 | 0.11 | ~ 0.23 |
| Elm | 6.9...8.3 | 4.6...4.8 | 11.8...13.8 | 0.23 | 0.2 | 0.39...0.46 |
| Hemlock, Western | 7.9...8.5 | 4.3...5.4 | 12.4...13.0 | 0.25 | 0.13 | ~ 0.41 |
| Iroko | 4.5...5.5...9.8 | 2.5...3.8...5.6 | 7.1...10.0...15.6 | 0.28 | 0.19 | 0.24...0.52 |
| Larch | 7.8...10.4 | 3.3...4.3 | 11.4...15.0 | 0.3 | 0.14 | 0.38...0.50 |
| Limba | 4.2...5.5...7.4 | 2.7...4.7...6.2 | 7.0...10.4...13.9 | 0.22 | 0.14 | 0.31...0.51 |
| Makore | 4.3...6.3...9.5 | 3.5...4.7...6.5 | 7.9...11.2...16.5 | 0.27 | 0.22 | 0.43...0.48 |
| Maple | ~ 8.0 | ~ 3.0 | 11.5...11.8 | 0.26 | 0.15 | ~ 0.25 |
| Meranti, Dark Red | 7.1...9.7...11.0 | 3.4...4.1...4.6 | 11.3...14.1...16.0 | 0.32 | 0.17 | 0.38...0.53 |
| Niangon | 7.6...8.5...9.2 | 2.9...3.7...4.5 | 10.0...12.9...14.0 | 0.33 | 0.18 | 0.33...0.47 |
| Oak | 7.8...10.0 | 4.0...4.6 | 12.6...15.6 | 0.36 | 0.16 | ~ 0.45 |
| Paran pine | 4.7...6.4...8.3 | 2.7...3.9...5.2 | 7.4...10.3...13.5 | 0.33 | 0.19 | 0.25...0.45 |
| Pear | ~ 9.1 | ~ 4.6 | 13.6...14.7 | 0.33 | 0.16 | ~ 0.48 |
| Pine | 7.5...8.7 | 3.3...4.5 | 11.2...12.4 | 0.36 | 0.19 | 0.37...0.41 |
| Ramin | ~ 9.4 | ~ 4.0 | 13.6...15.0 | 0.39 | 0.19 | ~ 0.47 |
| Red beech | ~ 11.8 | ~ 5.8 | 14.0...17.9...21.0 | 0.41 | 0.2 | 0.40...0.60 |
| Sapele | 4.3...7.0...9.8 | 4.1...5.4...7.6 | 8.5...12.6...17.8 | 0.32 | 0.24 | 0.29...0.61 |
| Sipo | 5.9...7.9...8.8 | 4.0...5.0...6.4 | 10.0...11.8...14.7 | 0.25 | 0.2 | 0.33...0.49 |
| Spruce | 7.8...8.0 | 3.5...3.7 | 11.6...12.0 | 0.39 | 0.19 | 0.39...0.40 |
| Teak | 4.2...5.8 | 2.1...3.0 | 6.9...9.4 | 0.26 | 0.16 | 0.24...0.32 |
| Tola | 4.0...4.2...5.7 | 1.9...2.0...2.8 | 6.5...7.6...8.3 | 0.2 | 0.11 | ~ 0.25 |
| Walnut | ~ 7.5 | ~ 5.4 | 13.4...14.0 | 0.29 | 0.18 | 0.25...0.45 |

Table 6: Total shrinkage dimension β in % during removal of the wood moisture content from fibre saturation to 0% Differential shrinkage/swelling dimension q in % for an alteration of the wood moisture content by 1% (from DIN EN 68100)

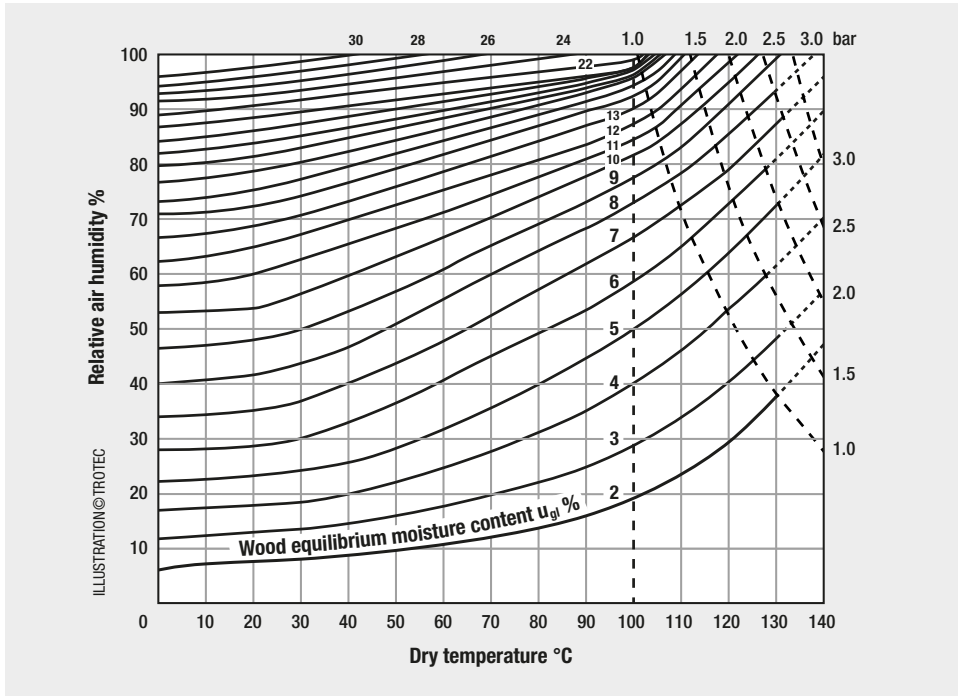

Figure 8: Equilibrium moisture content as a function of air humidity and air temperature ([3], according to Bollmann)

Equilibrium moisture content u_{gl}

By equilibrium moisture content is understood the moisture content of wood that has adjusted to the ambient conditions. There then exists an equilibrium between the moisture in the wood and the ambient humidity in which the wood gives up the same amount of moisture as it receives. [3]

This interrelationship between the moisture in the wood and the varying air humidity of the surrounding air at a particular temperature can be presented graphically.

For example at an air temperature of +20 °C. and a relative air humidity of 60 % an equilibrium moisture content of 11 % is established (see Figure 8).

Surface moisture content

With reference to the resistance measurement, the surface moisture content is denoted as the moisture content that

is measured with insulated electrodes inserted up to a depth of 1/6 of the thickness of the wood (see Section 3.2.3). [3]

Average wood moisture content

The average moisture content is denoted as the moisture content that is measured with insulated electrodes inserted up to a depth of 30 % (about 1/3) of the thickness of the wood. For a single measurement this is the value that comes closest to the wood moisture content that is determined from the kiln-drying method. [3]

Core moisture content

The core moisture content is denoted as the moisture content that is measured with insulated electrodes inserted up to a depth of 1/2 of the thickness of the wood. [3]

3.1.3 Assessment of the wood moisture content by means of some characteristic parameters

The aim of this section is to give the user a quick overview of the measured values that he has determined. At the same time he should be able to classify and professionally interpret the measured values determined on the basis of established characteristic parameters.

In Table 7 the average wood moisture content “u” is presented as the equilibrium moisture content as a function of the field of application. Accordingly the wood fitted in a heated and fully enclosed structure must exhibit an equilibrium moisture content “u” of 9 ± 2 %.

In Table 8 the current characteristic moisture contents are listed and the standard reference sources are also provided. In addition a number of other important guideline values for wood moisture content are also presented in Table 9.

In Table 10 a further important problem in wood processing and building diagnostics is introduced. Moulds and insects often damage the wood. The living conditions for these biological pests are primarily determined by the temperature and the moisture content in the wood.

The table gives a rough guide to the most favourable living conditions. In the relevant specialist literature the individual temperature and wood moisture content regimes are presented with differentiation between each species of mould and insect. Accordingly no attempt is made here to list these numerous species of moulds and insects.

According to DIN EN 335-1 it is fundamentally true to say that a wood moisture content of more than 20 % is necessary for the development of moulds that can destroy wood.

| Equilibrium moisture content in % | Field of application/installation conditions |
|-----------------------------------|---|
| 9 ± 2 % | Totally enclosed buildings with heating |
| 12 ± 3 % | Totally enclosed buildings without heating |
| 15 ± 3 % | Roofed open buildings |
| 18 ± 6 % | Structures that are exposed to the weather on all sides |

Table 7: Average wood moisture content as an equilibrium moisture content as a function of the field of application / installation conditions from DIN 1052-1

| Wood moisture content in % | Guideline value from | Characterisation of the guideline value |
|----------------------------|--------------------------------------|--|
| 9 ± 2 | DIN EN 13226 | Required moisture content of parquet at the point in time of delivery |
| 10 bis 15 | DIN 18355 | Required moisture content for components that are continuously in contact with external air (e.g. windows) |
| 12 ± 2 | DIN 68368 | Required moisture content for green wood for staircase construction |
| 16 bis 18 | DIN 4071 to 4073, DIN 68122 to 68128 | Measured reference moisture content for standard planks, shelves and skirting boards |
| 16 bis 18 | DIN 68126 T3 | Half-dried for solid wood profiles with shadow grooves |

Table 8: Guideline values for wood moisture content for the relevant fields of application

| Wood moisture content in % | Characterisation of the guideline value |
|----------------------------|--|
| 0 | Kiln-dried wood, oven-dry wood |
| 20 | Limiting value for the designation of “dry” according to DIN 4074 and DIN 68365 |
| 23 to 35 | Fibre saturation moisture content at a 100 % relative air humidity |
| 30 to 35 | Limiting value for the designation of “half-dry” according to DIN 4074 and DIN 68365 |
| > 35 | “Green” building wood according to DIN 4074 and DIN 68365 |

Table 9: Important moisture characteristic values

| | Biological damage | Temperature range °C | Wood moisture % |
|----------------|---|----------------------|-----------------|
| MOULDS | Infestation by wood-discolouring moulds | 18 - 25 | 30 - 120 |
| | Infestation by wood-destroying moulds | 3 - 38 | 35 - 60 |
| INSECTS | House longhorn beetle | 28 - 30 | 28 - 30 |
| | Common furniture beetle | 22 - 23 | 10 - 12 |
| | Brown lyctus beetle | 26 - 27 | approx. 16 |

Table 10: Compilation of the temperature and wood moisture content regimes within which damage can occur to the structure as a result of biological infestation. (from [4])

3.2 Wood moisture content measurement – resistance principle

This method is an indirect method of measurement, since conclusions are drawn from the wood’s electrical conductivity concerning its moisture content.

Before describing the actual measuring procedure the measurement principle is first of all described, so that one is better able to assess the method with regard to its accuracy and the possible problems of measurement. The sensors that are available are then presented according to configuration, fields of application and the mode of operation.

Following DIN EN-13183-2 (July 2002) a frequently occurring measurement task is then described which can be fulfilled with the measurement device without any problems.

In conclusion reference is made to the problems and interference effects so as to be able to achieve the most precise measurement results possible.

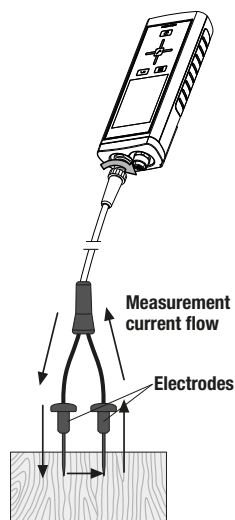

Figure 9: Sketch of resistance measurement with the T3000

3.2.1 Measurement principle

Using the resistance or conductivity measurement principle an electrical measurement current is generated in the measurement device, which with the aid of electrodes is conducted through the wood.

With increasing water content in the wood that is being investigated the resistance reduces, or in other words the conductivity increases.

The measured resistance is thus inversely proportional to the quantity of water present. If the medium that is being measured has a high resistance the moisture content is low. If it has a low resistance the moisture content is high.

Figure 9 illustrates this procedure. The measurement device generates a measurement current and a certain voltage.

This measurement current flows via the first electrode into the material and via the second electrode back to the current source. The voltage at the electrodes and the magnitude of the measurement current are known, or, in other words, are prescribed.

From Ohm's Law the electrical resistance of the piece of wood can thus be calculated.

In Figure 10 this relationship is presented in terms of a moisture content/resistance curve. According to this curve 10 MOhm represents a wood moisture content of 12 % and 0.1 MOhm a wood moisture content of 36 %.

The measurement of wood moisture content using the resistance principle can be used particularly well in the region between 6 % and 30 % content. Between the kiln-dried state and about 6 % moisture content the resistance decreases exponentially. From there up to the specific wood fibre saturation point (about 30 %) the relationship is nearly linear and above the fibre saturation point the resistance alters only slightly with moisture content.

For this reason most measurements above this wood moisture content – depending upon the species of wood, its green density and its temperature – are increasingly inaccurate (Figure 13).

Influence of the conductivity

This explains, amongst other reasons, why it is necessary before each moisture measurement for the species of wood that is to be measured to be selected. Not every species of wood exhibits the same conductivity behaviour,

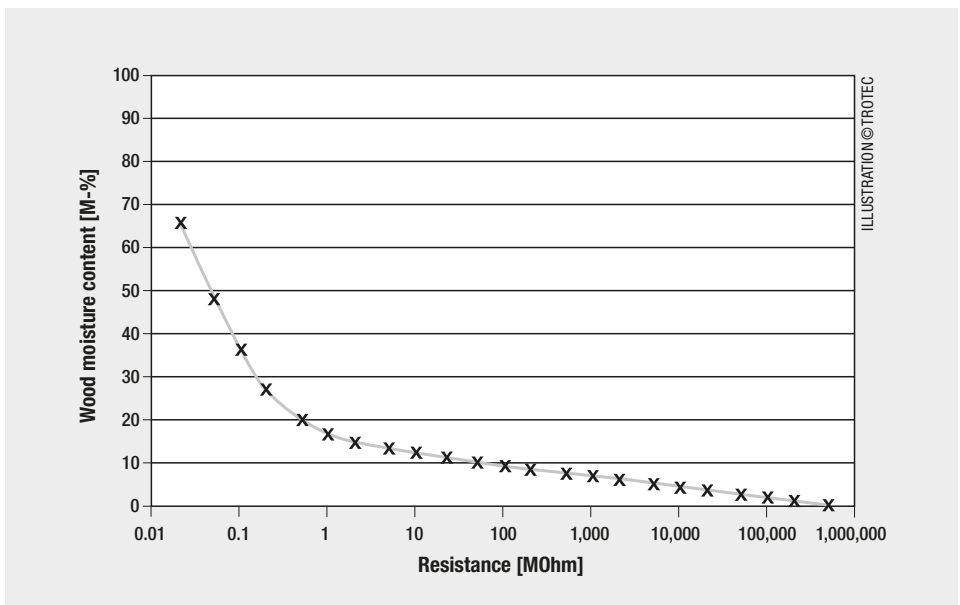

Figure 10: Representation of a resistance/wood moisture content measurement curve for the T3000

so the timbers must be divided into distinct classes (according to material numbers). [9]

Thus, for example, in the case of the stone pine and the Douglas fir (material number 12) the measured resistances are identical to the actual wood moisture content.

In contrast the same resistance in the case of the Swiss pine (material number 2) corresponds to a higher wood moisture content. For this reason a number of resistance curves are stored in the measurement device, and four of these are shown in Figure 11.

Influence of the temperature

The conductivity is also affected by the temperature of the wood. Thus a temperature rise in the hygroscopic moisture range causes an apparent increase in the moisture content by 0.03 to 0.15 % [1]. This measurement error can be corrected by means of the temperature compensation in the measurement device. [10]

The resistance curves for the selected species of wood are automatically adjusted as a function of the device temperature (see Figure 12).

In order to be able to carry out precise moisture measurements, the temperature of the wood and the temperature of the measurement device must be identical.

Practical tip:

A pyrometer can be used for a quick check of the wood surface temperature.

If this is not the case (e.g. cold wood or measurement during wood drying), the SDI temperature sensor (e.g. TS 131 SDI) can be connected to the 5-pin connector.

The temperature value of the wood must be transferred to the T3000, which can compensate the temperature-dependent measurement error.

Procedure for non-classified species of wood

The description of the resistance principle and the classification of the species of wood that is connected with it make it clear that for the wood that is to be measured a resistance/moisture content curve (material number) must be provided.

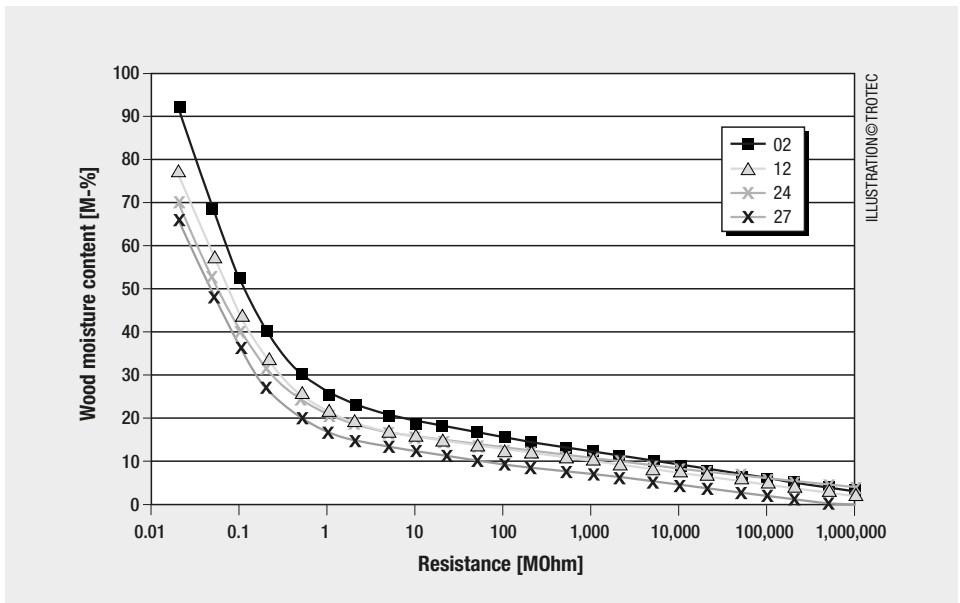

ILLUSTRATION © TROTEC

Figure 11: Wood moisture content as a function of the measured resistance for the species 02, 12, 24, 27 at 20 °C

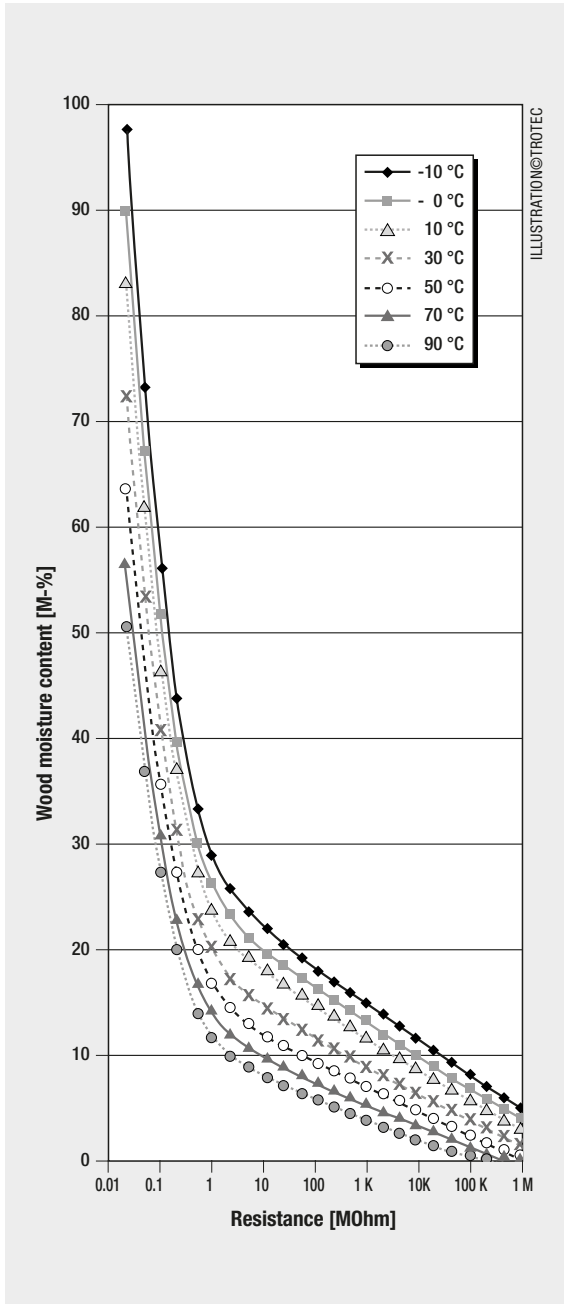

Figure 12: Temperature compensation for wood species number 12

If a species of wood is not listed in the Trotec® wood species table it is recommended that the species is measured using material number 08.

This curve represents the average value of all the material curves stored and thus minimises the measurement error. For an accurate determination of a particular wood moisture content measurement curve please make contact with us.

Example of a comparison of moisture content measured values with wood moisture content measurements taken in accordance with the resistance principle

The resistance/moisture content measurement curves for selected items of wood have been checked and optimised in the course of a research project undertaken by the Institute for Building Research at the RWTH Aachen University.

On ten different measurement dates resistance measurements were performed using the T3000 and at the same time the moisture contents were determined using the kiln-drying method.

The resistance measurements were performed at the surface, at 1/3 of the thickness of the section, and also in the core of the test sample.

Examples are brought together in Figure 13 of measurements performed on spruce, oak and beech samples.

The results presented show clearly that the resistance measurement definitely increases in accuracy with decreasing water content. The highest accuracy of measurement is in the range between 6 and about 28 % wood moisture content.

| Wood species | Name | Code-no. T3000 |
|----------------------------------|--|----------------|
| Spruce | Picea abies | 8 |
| Pine | Pinus sylvestris | 1 |
| Larch | Larix decidua | 9 |
| Fir | Abies alba | 1 |
| Douglas fir | Pseudotsuga menziesii | 12 |
| Elm | Wych elm (Ulmus glabra) | 8 |
| Beech | Fagus sylvatica | 14 |
| Oak | (Quercus robur or Quercus petraea) | 12 |
| Robina | Rubinia pseudoacacia | 8 |
| Chestnut | Aesculus hippocastanum | 8 |
| Maple (Canadian and American) | Acer platanoides, Acer pseudoplatanus | 8 |
| Ash | Fraxinus excelsior | 8 |

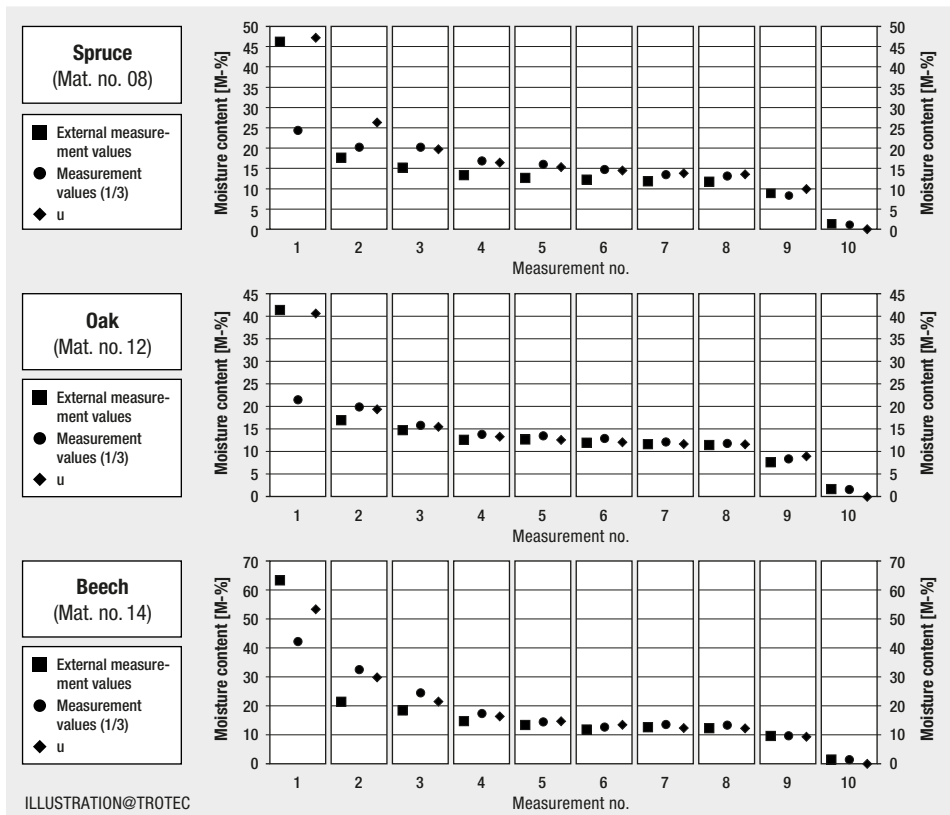

Comparison of moisture content measured values with wood moisture content measurements taken in accordance with the resistance principle performed on spruce, oak and beech samples.

3.2.2 Electrodes for wood moisture content measurement – operation and measurement procedure

For determination of the wood moisture content different types of design can be used for the passive electrodes, and these exhibit advantages and disadvantages according to the field of application. In order to achieve the most accurate measurement possible the selection of the electrodes must be held within certain parameters.



TS 60 hand electrode

The TS 60 hand electrode comprises the impact-resistant plastic body and two hexagonal union nuts. The electrode tips can be inserted into the union nuts – these are available in the following lengths:

- 20 mm (max. penetration depth 14 mm)
- 30 mm (max. penetration depth 24 mm)
- 40 mm (max. penetration depth 34 mm)
- 60 mm (max. penetration depth 54 mm)

Fields of application include, amongst others, the recording of wood moisture content for cut timber or sheet materials made out of wood (e.g. chipboard or fibreboard).

In operation the following points are to be noted:

1. Fit the union nuts with the electrode tip in question and tighten with a spanner.
2. Perform the moisture content measurements in accordance with DIN EN 13183-2 (see also Section 3.2.3).
3. Insert the needles at right-angles to the fibre direction in the material being measured. Here the insertion depth should be selected to correspond to the wood moisture content to be determined. As a rule it is 1/3 of the thickness of the wood.

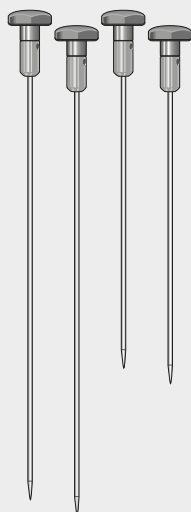

TS 8/200 and TS 8/300 round electrodes, 4 mm

The TS 8/200 and TS 8/300 insertion electrodes are non-insulated electrodes that differ only in their lengths (200 mm or 300 mm).

The field of application is in the measurement of moisture on loose mounds of material such as, for example, wood shavings or sawdust, amongst others.

In operation the following points are to be noted:

1. Before insertion of the electrodes the material being measured must be compressed.

Sawdust should be compressed with a pressure of approx 8 kg.
In the case of wood shavings a compression force of 1 kg is sufficient.
2. Before insertion of the electrodes any possibility that there are foreign bodies in the mound must be excluded.



TS 70 ram electrode

The ram electrode essentially comprises a hammer handle, guided in its movement, and the electrode tips. In general applications the non-insulated electric tips are used.

For precise measurements of zones and depths, especially in woods with a varying distribution of moisture content (e.g. with pockets of liquid) the use of teflon coated electrode tips is recommended. These are available in lengths of 45 and 60 mm.

In operation the procedure should be as follows:

1. Fit the union nuts with the electrode tip in question and tighten with a spanner.
2. Insert the electrodes at right-angles to the fibre direction in the material being measured.
3. Place the probe at right-angles to the workpiece and drive the electrode tips in to the required depth for measurement using the hammer handle movement. The depth can be checked with the aid of a scale.
4. After the measurement procedure the tips should be carefully pulled out of the material being measured using the hammer handle – with the direction of the hammer movement upward. In this way any bending of the tips is avoided.

The measurement procedure for resistance measurements

The temperature detection in wood moisture measurement can be performed using two different methods. Firstly, using an NTC sensor. On the other hand without an NTC sensor, whereby the detected or manually entered temperature inside the unit of the T3000 is used for compensation.

The background to this is the temperature-dependent conductivity of the wood (see measurement principle, Section 3.2.1). With a wood temperature that is higher than the temperature of the device, a higher wood moisture content is displayed than that which is effectively present.

Before the actual measurement process therefore always check the temperature conditions. For this purpose, the surface temperature of the wood species is measured for example with a pyrometer or contact temperature probe (e.g. TS 131 SD, type NTC) and will be compared with the device temperature (display field T3000).

If both temperatures are identical, the measuring operation can be continued. If the two measured values differ, the correct temperature value of the measured wood must be transferred to the T3000. If you are using the correct timber temperature value, the T3000 can compensate for the temperature-dependent measurement error for the moisture content.

Measurement procedure without NTC sensor

(display temperature and wood temperature are identical)

1. Select sensor depending upon the measurement task and the field of application.
2. Perform the operation and measurement preparations appropriate to the electrodes selected.
3. Connect electrode(s) with the TC 20 cable to the BNC connector plug
4. Switch on the device.
5. Enable measurement method by selecting the sensor identifier for wood moisture measurement.
6. Set the type of wood to be measured via the Mat-No. in the configuration menu.

For a list of supported types of wood with the corresponding material numbers can be found right in the T3000 or in our woods database under www.trotec.com.

7. The display shows the current measured value in % moisture content in the display field.

Furthermore, the display field shows the device temperature, which is used for temperature compensation.

8. Read off the wood moisture content and the temperature in the display.



Measurement procedure with NTC sensor

(display temperature and wood temperature are not identical)

1. Select sensor depending upon the measurement task and the field of application.
2. Perform the operation and measurement preparations appropriate to the electrodes selected.
3. Connect electrode(s) with the TC 20 cable to the BNC connector plug
4. Connection the NTC sensor to the 5-pole connector plug.
5. Switch on the device .
6. First identify the exact surface temperature of the wood with the connected NTC sensor and enter this value in the T3000.
7. Enable measurement method by selecting the sensor identifier for wood moisture measurement.

8. Set the type of wood to be measured via the Mat-No. in the configuration menu.

For a list of supported types of wood with the corresponding material numbers can be found right in the T3000 or in our woods database under www.trotec.com.

9. The display shows the current measured value in % moisture content in the display field.

Furthermore, the previously entered measurement temperature of the temperature sensor in °C appears, which is used for temperature compensation.

10. Read off wood moisture content and temperature on the display after a response time of about 10 seconds.

3.2.3 Measurement of the wood moisture content in cut timber

Determination of the wood moisture content on a piece of cut timber is the type of measurement that must be performed most frequently. Accordingly the essential steps in such a resistance measurement are listed here in accordance with DIN EN 13183-2.

The measurement procedure is subdivided into four work steps. These are the task-specific adjustment of the device, the selection of the measurement position, the frequency of the measurements, and the documentation of the test results.

1. Work step – adjustment of the device

In accordance with the details given above the **electrode** suitable for the measurement of wood moisture content is selected and connected to the base device.

Then, as described above, the sensor setting for wood moisture measurement is activated. This type of wood is then selected in the T3000. You can find the relevant material number in the wood species table or in the Internet under www.trotec.com.

There follows a check using the pyrometer as to whether the wood temperature agrees with the device temperature. If this is not the case there is either a wait until the two temperatures agree with each other or the NTC-temperature sensor is introduced, with the aid of which a temperature compensation can be performed regarding the specific read-off of surface temperature on the material being measured.

2. Work step – selection of the measurement position

Fundamentally the measurement is to be performed at locations at which no visible defects (e.g. cracks, resinous inclusions, knots) can be detected. The measurement position is then to be selected in accordance with Figure 14.

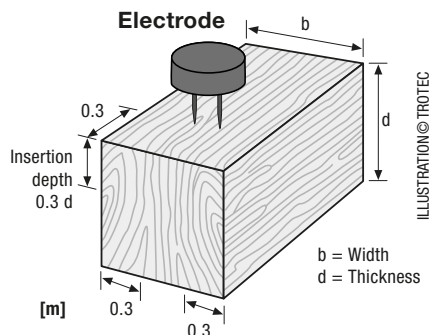

Figure 14: Location of the measurement position (from DIN EN 13183-2)

The electrode is to be inserted at right-angles to the fibre direction at a distance of 0.3 m from one of the two ends of the cut timber. If the test piece is shorter than 0.6 m the measurement position is to lie in the centre of the material being measured. To determine the average wood moisture content the insulated electrodes should then be inserted to a depth of 0.3 d (d = thickness of the wood).

3. Work step – frequency of the measurements

Depending upon the pieces to be tested different measurement frequencies are required according to DIN EN 13183-2 and these are given in Table 11.

4. Work step – documentation

In any documentation of the test results the following data should always be present:

- tester, date of testing
- designation of the cut timber: type, dimensions, number
- supplier, customer, internal coding etc.
- data concerning the type of unit and the measurement parameters: electrode type and measurement depth, wood species coding, temperature setting

| | | | | | | |
|---|---|---|---|---|---|-----|
| Number of test pieces | 1 | 2 | 3 | 4 | 5 | > 5 |
| Number of measurements per test piece ¹⁾ | 3 | 3 | 2 | 2 | 2 | 1 |

¹⁾: The measurement positions should be selected on a random basis along the length at a distance of 0.3 m from the end (or in the centre in the case of test pieces shorter than 0.6 m).

Table 11: Sampling points and measurement frequency (from DIN EN 13183-2)

DOCUMENTATION

| Customer | Supplier |
|---------------------------|---------------------------|
| _____ Name | _____ Name |
| _____ Street | _____ Street |
| _____ Postcode / place | _____ Postcode / place |
| _____ Phone / Fax | _____ Phone / Fax |
| _____ Contact | _____ Contact |

| T3000 measurement | Test piece |
|---------------------------------|----------------------------|
| _____ Type of electrode | _____ Species of wood |
| _____ Measurement depth [cm] | _____ Dimensions |
| | _____ Content of supply |

| Measurement parameters | Temperature compensation |
|--|--|
| <div style="display: flex; justify-content: space-around;"> <div style="border: 1px solid black; width: 60px; height: 20px; margin-bottom: 5px;"></div> <div style="border: 1px solid black; width: 60px; height: 20px; margin-bottom: 5px;"></div> <div style="border: 1px solid black; width: 60px; height: 20px; margin-bottom: 5px;"></div> </div> <div style="display: flex; justify-content: space-around; font-size: small;"> <div>Mat.-Number / Wood species coding</div> <div>Wood temperature °C</div> <div>Device temperature °C</div> </div> | <input type="checkbox"/> with temperature sensor <input type="checkbox"/> without temperature sensor |

| Test piece | 1 | 2 | 3 | 4 | 5 |
|-------------------------------|---|---|---|---|---|
| Measurement result in M- % | | | | | |

Confirmation

Company

Street

Postcode / place

Company

Place, date / signature

ILLUSTRATION © TROTEC

3.2.4 *Interference effects and instructions to be followed for resistance measurements*

As for any technical measurement investigation the basic rule applies also for this measurement method: "Always create the same conditions for measurement and the possible sources of error are then minimised!"

From the measurement **principles described** above and the **specific material properties** the following instructions emerge:

- **Before measurement, the right type of wood should be selected (see wood species list).**
 - For measurements on cut timbers the instructions in DIN EN 13183-2 should be observed.
 - For the task in question select the most suitable electrode.
 - Do not use any insertion electrodes that are bent or have faulty insulation.
 - Always position the electrodes at right-angles to the direction of the wood fibres. The conductivity at right-angles to the fibre direction is lower than along the fibre. It varies according to the species of wood by a factor of between 2.3 and 8.
 - Select the **insertion depth** for the electrodes in accordance with the following criteria: surface moisture content = 1/6 plank thickness, average wood moisture content = 1/3 plank thickness (comparison value for the kiln-drying method), core moisture content = 1/2 plank thickness.
 - **In the selection of the measurement positions three points are to be noted:**
 1. *Always measure the moisture content of the material being measured at three positions, in order to achieve a sufficient accuracy from the arithmetic mean of the results.*
 2. *Do not take measurements on the end faces since dry areas are present there.*
 3. *As far as possible do not measure over cracks, knots or resinous inclusions in the timbers.*
- Oil-based and/or water-based wood protective agents influence the measured result.
 - As far as possible do not measure any wood that exhibits a temperature of less than -5 °C.
 - Avoid generating static electricity as a result of friction in the material being measured, since this would create a distorted measured result.
 - In the case of a wood moisture content that is lower than 10 %, electrostatic forces can occur on the test piece that can falsify the measured result very severely. Experience shows that this situation occurs at the outlet of veneer drying plants. In all such cases the static charge should be removed by means of suitable earthing measures.
 - The highest accuracy of measurement lies in the range between 6 and about 28 % wood moisture content. Above 28 % the measured result become more inaccurate, since the resistance only alters further slightly with moisture content. Below 6 % wood moisture content practically no meaningful measurements are any longer possible, because the result is determined by molecular forces of attraction.
 - Above the fibre saturation point the measurement of moisture content loses its accuracy.
 - The TS 60 hand-held electrode and the lower plastic part of the TS 70 should be cleaned regularly after use to prevent uncontrolled flow of current between the electrodes. This would lead to incorrect measurements. Distilled water is suitable for cleaning.
 - The temperature displayed on the measurement device must be nearly identical with the wood temperature. If this is not the case, the exact temperature should be determined using the NTC sensor and included for automatic correction of the moisture content. At a room temperature of 20 °C and a wood temperature of 30 °C the measured result is distorted by about 1.5 % in the upward direction, if no attention is paid to the temperature compensation.
 - Do not use any defective cables.

- The accuracy of the measurement is dependent upon the contact pressure of the measurement electrodes. The electrodes must be in such good contact with the wood that the interface resistance is small compared with the resistance to be measured.
- As a check on the samples measured the values determined should be checked randomly against a kiln-dried sample for comparison purposes.

3.3 Wood moisture content measurement – capacitive method

In addition to resistance measurements the T3000 provides the option of determining the wood moisture content via the capacitive measurement method.

This similarly indirect method is particularly suitable for orientating measurements if levels of moisture absorption and moisture content distributions are to be determined in wood materials.

The relative measurement then permits rapid, non-destructive conclusions allowing moist and dry zones to be differentiated.

Fundamentally it is true to say that results using this measurement method cannot achieve the accuracy of the resistance measurement method.

3.3.1 Measurement principle

The capacitive measurement method is an indirect method, since it is not the water content that is determined, but rather the dielectric material property of the wood material that is measured.

To be more precise it is the dielectric constant “ ϵ ” of the wood that is determined. This constant is, like the electrical resistance, a property of the wood material whose value alters if the material absorbs moisture. [2]

The measurement works by influencing a capacitive electric field. In the TS 660 SDI sensor the measurement field forms between the active spherical head capacitor and the wood material that is to be assessed (see Figure 15).

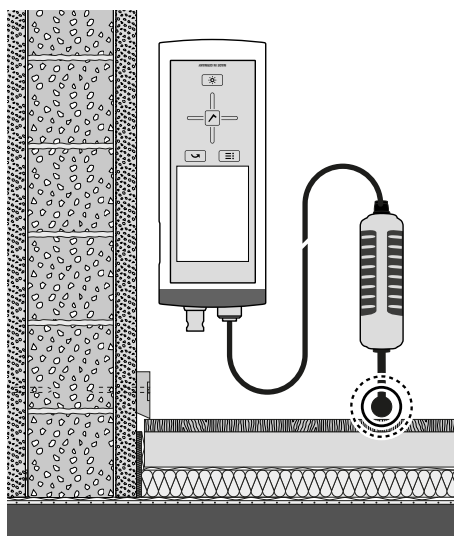

Figure 15: Schematic representation of capacitive measurement of wood moisture content on parquet with the T3000.

The alteration of this electric field by the physical properties (e.g. green density and moisture content) is recorded and displayed as a digital numerical value (digit).

You can find a more detailed explanation of the measurement principle in section 4.3 (Measurement of building material moisture content).

3.3.2 The TS 660 SDI sensor for wood moisture content measurement - measurement procedure and operation

For orientating measurements of the moisture content distribution in wood materials the TS 660 SDI capacitive sensor can be introduced.

In operation it should always be noted that the following parameters must be maintained to obtain as accurate a measured result as possible.

The TS 660 SDI essentially comprises a spherical head and a shaft that exhibits a well-defined surface by which it can be held.

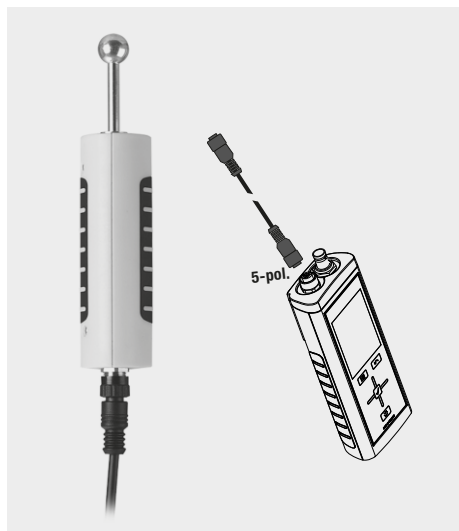

In operation the following points are to be noted (see also the section on building material content measurement):

1. The depth of penetration of the measurement field is 2 to 4 cm.
2. The sensor may neither be fixed in the locking slit of the base device, nor the sensor grip held too high up (see Figure "Wrong/right"). In both cases too high a measured value would be displayed.

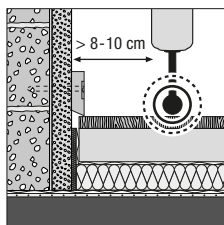

3. Place the sensor firmly down as nearly at right-angles to the material being measured as possible. To avoid measuring errors, maintain a minimum distance of 8 to 10 cm from the corner regions.

Practical tip:

In the run-up to a wood moisture measurement it is possible, using the capacitive method, to localise zones of moisture near the surface quickly and simply. Then, according to the task in question, representative samples can be taken for the wood moisture measurement.

Measurement procedure

If an estimation of the moisture distribution near the surface of the wood material is to be performed, attention must basically be paid to the following work steps:

1. Connect the TS 660 SDI sensor with the TC 30 SDI connection cable to the measurement device.
2. Switch on the device.
3. Setting measurement method in the T3000.
4. Performing a function check. Hold the sensor at the grip and hold up in the air. The sensor calibrates itself; calibration is confirmed by a several acoustic signals.

The displayed value should be between 0 and 5 digits, otherwise the sensor is not calibrated accordingly (see operating instructions chapter 6.8).

5. Press the spherical head of the sensor hard down onto the surface of the material and align the shaft at right-angles to the surface.

Care should be taken that the sensor is placed on surfaces that are as smooth as possible. Rough surfaces produce faulty measurement values.

6. In the display the current measured value is shown in the display field of sensor 1 without a unit. For a better understanding this display value is to be understood as a digit (digital numerical value).
7. Read off the measured value in the display and determine the comparison value from the accompanying tables (see Section 3.3.4).

Practical tip:

With the TS 660 SDI the alarm function of the T3000 can also be brought into play.

Advantage: With the alarm limit value sensor, large areas can also be measured quickly and effectively. The user can concentrate on the target without having to watch the measured values all the time on the display.

As soon as the preset limit value is exceeded, the TS 660 SDI sensor alerts the user with an acoustic signal!



The alarm function makes possible an unconventional and extremely effective mode of use for area measurements:

Here the measurement device is held such that the TS 660 SDI sensor on the connected TC 30 SDI cable makes contact at nearly at right-angles as possible to the floor.

Now the sensor can be held beside the user as he walks over the area to be measured. If the defined limit value is exceeded the sensor alarms the user.

It is probably not possible to carry out measurement of an area any faster than this!

3.3.3 Interference effects and instructions to be followed for the capacitive measurement method

From the measurement principle as described above important instructions emerge for the use of the TS 660 SDI in measurement:

- The measurement results should be used exclusively to provide orientating measurements of moisture content. It is only possible to draw conclusions of absolute moisture content in M-% in the case of measurements that have been taken with the same parameters and material compositions, as shown in Figure 13.
- The bulk density of the wood is an important influence on the measured value. The higher the bulk density, the higher the measured value.
- Before taking measurements any contaminants must be removed from the surface of the wood (e.g. paint residues, dust).
- If any metal is contained in the wood material (e.g. nails, screws, etc.) and is located within the measurement field of the sensor, the measured value increases dramatically.
- If the spherical head is held in corners (e.g. window frames), the measured value is basically higher since there is more material in the radiation field of the measuring head. A distance that is greater than 8 to 10 cm from the corner must be maintained.
- Do not tilt the spherical head.
- Always press the spherical head hard down on to the surface to be measured.
- The depth of penetration with the TS 660 SDI sensor lies at between 2-4 cm according to the bulk density and the wood moisture content. It is not possible to

draw any conclusions concerning zones of the wood at greater depths.

- Rough surfaces will always show a measured value that is too low.
- In the case of wood thicknesses of less than 2 cm, there is the risk that moisture content values of adjacent layers of material may influence the measured value.

3.3.4 Comparison values for the assessment of the measured capacitive values

Taking into account the interference effects previously described, the measured values (digits) that can be determined can be divided into two main moisture content zones.

These are the “dry zone” that exists at room temperature in dry, occupied premises and the “saturation zone” that is defined such that not only is water registered that is held in the cell wall, but also free water in the cell cavities (see Section 3.1.2).

| Display T3000 | Wood moisture range |
|---------------|----------------------|
| < 50 digits | Dry |
| > 80 digits | Saturation threshold |

Table 12: Orientation values for the assessment of wood moisture content

Since, depending on the parameters involved, the measured value display of the capacitive measurement method is subject to strong fluctuations, **this procedure can only serve to provide an orientation of indicators (dry, moist, wet).**

For this reason a resistance measurement should always be preferred for measurements where higher accuracy is demanded.

4. Mineral building materials – determination of moisture content

4.1 Fundamentals regarding moisture content in building materials and characteristic parameters

At the present time the most accurate and most reliable methods for determining moisture content in mineral building materials are the kiln-drying method and the CM method.

Since these methods are not non-destructive and moreover are time-consuming, the approximate moisture content can also be determined using the electrical resistance measurement method. The T3000, used with sensors specific to the task in hand, fulfils the technical prerequisites in this respect.

With regard to the determination of moisture content the main focus is on porous, mineral building materials. In the context of the practice handbook particular attention is devoted here to the mortars (screeds, plasterwork) and concretes. For example, a floor covering may only be laid on a screed if the moisture content of the latter is less than a certain limiting value.

For the assessment of the status of the moisture content and the specific measurement tasks, some fundamental knowledge is first of all necessary, as in the case of wood. The ambient conditions surrounding the building material have a great influence on the status of the moisture content in the building material. In addition the constitution of the building material, its porosity and the distribution of sizes of pores, must be taken into account.

4.1.1 Definition and options for determination of building material moisture content

The building material moisture content “u” is defined in % in exactly the same way as wood moisture content, and indicates the ratio between the mass of water contained in the building material m_u and the mass of the kiln-dried building material m_0 . The following formula is used to determine moisture content:

Mass-related moisture content =

$$\frac{\text{Moist weight} - \text{dry weight}}{\text{Dry weight}} * 100$$

The most accurate determination of building material moisture content is achieved using the kiln-drying method that has been referred to above. The material sample extracted is weighed, fully dried, and then weighed a second time. By subtracting the dry weight from the moist weight, one obtains the weight of the water that was previously contained in the sample.

In practice the volumetric percentage (Vol.-%) is also provided alongside the mass percentage (M.-%). The volume-related moisture content includes both the bulk density of the building material and that of the water in the measurement.

The following formula applies:

$$u_m = (\rho_w / \rho_b) * u_v \text{ [M.-%]}$$

$$\text{or } u_v = (\rho_b / \rho_w) * u_m \text{ [Vol.-%]}$$

where:

u_m = mass-related moisture content

u_v = volume-related moisture content

ρ_w = bulk density of the water at 1,000 kg/m³

ρ_b = bulk density of the building material in kg/m³ from tables

As a further direct measurement method the so-called CM measurement can be applied. Its advantage compared with the kiln-drying method lies in the quicker determination of the measured result.

In the CM method a chemical reaction is brought about between the moisture that it is held as water in the building material, and calcium carbide. The calcium carbide reacts with the water to form acetylene and calcium hydroxide.

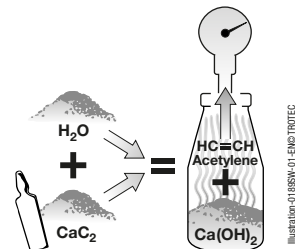

Figure 16: Schematic representation of the chemical reaction mechanism in the CM measurement.

This chemical reaction is allowed to take place in a closed pressure vessel that is fitted with a pressure gauge. The acetylene gas that is released produces an excess pressure that rises with increasing water content of the test piece.

In contrast to the kiln-drying method (mass-%) the measured result is given in CM-% units, and in the case of cement-based building materials turns out to be fundamentally lower than that achieved using the kiln-drying method. The reason for this is based on the fact that it is exclusively the free water on the grain surface and in the pores that is being determined. The physically-bound water is not registered. **The calcium sulphate building materials form an exception to this rule – for these the mass-% is equal to the CM-%.**

4.1.2 Mechanisms for moisture transport in mineral building materials

Porous mineral building materials are penetrated by a network of pores of different types, sizes and shapes. These pores are responsible for the transport and storage of the water in the building material. Here it is possible to differentiate between three water content regimes, the sorption moisture regime (also called the hygroscopic water content regime), the capillary water regime, and the supersaturation regime [5]

The differentiation between the three regimes originates in the storage mechanism and the primary transport mech-

anism of the water in the porous spaces of the building material (see Figure 18, phases 1 to 6) [5].

The sorption regime is characterised by the process of diffusion and the water storage takes place by means of absorption processes, i.e. water is stored out of the ambient air in the walls of the pores.

In a very dry building material (1) the whole of the water vapour that penetrates into the pores is absorbed in the walls. Transport in the literal sense of the word does not take place. The water is only stored.

If the pore walls are covered with one or more molecular layers (2), the pore space for water vapour is diffusible (i.e. the water can flow through). The regime of sorption moisture is also known as the hygroscopic regime, since the building material takes in moisture out of the air.

The regime that is adjacent to the hygroscopic regime is the capillary regime. Here water transport takes place by means of unsaturated water flow through the pores.

Firstly the narrow pore passages fill with water (3) and in the expanded porous spaces a sorbate layer forms on the surface. This sorbate layer grows in the course of the ongoing water storage, such that one speaks for the first time of a fluid water transport (4). This transport phase that is beginning is correspondingly also significantly more effective than the diffusion transport phase.

| rel. air humidity | Water content | Water content regime | Storage mechanism | Primary transport mechanism |
|---------------------------------|------------------|------------------------|------------------------|-----------------------------|
| $\varphi = 1$ | U_{max} | Supersaturation regime | - | Water flow |
| $\varphi = 1$ | U_F | | | |
| ILLUSTRATION 0190-01-EN ©TROTEC | $\varphi = 0,95$ | Capillary regime | Capillary condensation | Unsaturated pore water flow |
| | $\varphi = 0$ | $U=0$ | Sorptions regime | Adsorption |

Figure 17: “Bar chart” (water content regimes in a fine porous, hygroscopic building material) [5]

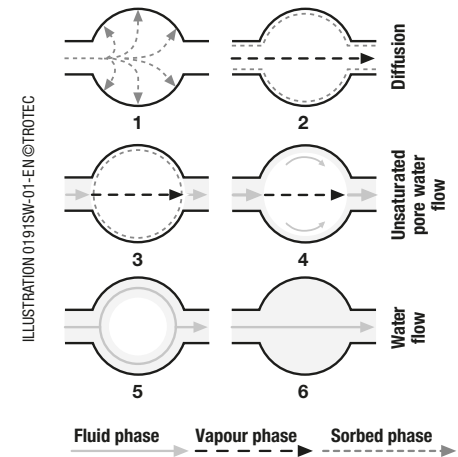

Figure 18: Schematic representation of the storage and transport mechanisms of water in porous mineral building materials [5]

In the third water content regime, the supersaturation regime, the relative air humidity has the value 1 (Figure 17). The state of equilibrium between the air and moisture content no longer exists. In the expanded porous basis there is now so much water that one can speak of a relaxed water transport mechanism (5) (6). [5]

Equilibrium moisture content - hygroscopic equilibrium moisture content

The equilibrium moisture u_{gl} describes for mineral building materials a certain moisture state in the same way as has already been described above for wood. Thus as a function of the air temperature and the relative air humidity the moisture content of the building material is adjusted such that the same amount of moisture is received from the environment as is given up to the environment.

If the relative air humidity reduces the building material releases water and the water content reduces. If the relative air humidity of the ambient air increases the building material receives more water. The water content of the building material increases.

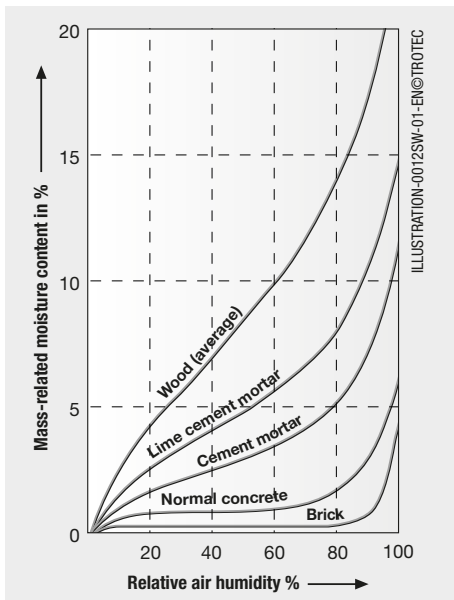

Figure 19: Sorption isotherms for various building materials [19]

| Month | Relative air humidity % | |
|-----------|-------------------------|----------------|
| | 7.00 - 14.00 h | 14.00 - 6.00 h |
| January | 88 | 89 |
| February | 72 | 89 |
| March | 60 | 86 |
| April | 54 | 81 |
| May | 54 | 79 |
| June | 54 | 81 |
| July | 55 | 85 |
| August | 60 | 90 |
| September | 69 | 93 |
| October | 78 | 91 |
| November | 82 | 90 |
| December | 84 | 93 |

Table 13: Relative air humidity (θ) in Frankfurt, Source: Weather station at Frankfurt am Main Airport.

Climatic conditions in the external environment that would bring with them a permanent relative air humidity of less than 50 % do not predominate in Central Europe in general and can only be produced by means of technical aids. In Table 13 you can find a listing of typical air humidity values using Frankfurt as the example.

The functional relationship between the water content and the relative air humidity can be represented by the so-called sorption isotherms. In Figure 19 five sorption isotherms are brought together schematically; they all show an s-shaped characteristic.

As one can see from the diagram, the moisture content of brick hardly alters in the range from 0 to 80 % relative humidity.

Within the air humidity range from 80 to 100 % the brick moisture content then shows a sharp increase to 4 mass-%. In contrast in the case of wood an almost linear relationship between relative air humidity and wood moisture content can be discerned.

Thus it can be established that the wood moisture content is subject to strong fluctuations as a function of the environmental climate.

In the case of mineral building materials such as normal concrete and brick, the moisture content only starts to alter at high relative air humidities of more than 80 %.

| Row | Building materials | | Practical moisture content ¹⁾ | |
|-----|--|---|--|----------------------------|
| | | | volume-related ²⁾ u_v in % | mass-related u_m in % |
| 1 | Brick | | 1.5 | – |
| 2 | Sand-lime bricks | | 5 | – |
| 3 | 3.1 | Concrete with closed structure with porous additives | 5 | – |
| | 3.2 | Concrete with closed structure with nonporous additives | 15 | – |
| 4 | 4.1 | Lightweight concrete with no-fines structure and nonporous additives in accordance with DIN 4226 T1 | 5 | – |
| | 4.2 | Lightweight concrete with no-fines structure and porous additives in accordance with DIN 4226 T2 | 4 | – |
| 5 | Gas-aerated concrete | | 3.5 | – |
| 6 | Plaster, anhydrite | | 2 | – |
| 7 | Mastic asphalt | | ≈ 0 | ≈ 0 |
| 8 | Inorganic materials in loose ballast: expanded gas-aerated volcanic stone (e.g. expanded perlite) | | – | 5 |
| 9 | Mineral fibre insulation materials made from fibres of glass, stone, furnace clinker (smelter) | | – | 1.5 |
| 10 | Cellular glass | | ≈ 0 | ≈ 0 |
| 11 | Wood, plywood, chipboards, fibreboards, wood wool lightweight boards, cane boards and mats, organic fibre insulation materials | | – | 15 |
| 12 | Plant fibre insulation materials made out of sea grass, wood, peat, and coconut fibres and other such | | – | 15 |
| 13 | Cork insulation materials | | – | 10 |
| 14 | Foam plastics made of polystyrene, polyurethane (hard) | | – | 5 |

¹⁾ Practical moisture content is understood to mean the moisture content, which, in the study of satisfactorily dried-out structures that are inhabited by people over the long-term, would not be exceeded in 90 % of all cases.

²⁾ In the case of perforated bricks, hollow floor sections, or other such building elements with air spaces, volume-related moisture content always refers to the material alone, without the air spaces.

Table 14: Practical water content of building materials taken from DIN 4108, Part 4

4.1.3 Assessment of the building material moisture content with some limiting values

In the assessment of the moisture content of building materials the ambient conditions must always be taken into account, since **all building materials and other materials alter the moisture content depending upon air temperatures and humidities.**

The building materials are never completely dry, but retain a quantity of water that is dependent on the ambient conditions. In the case of newly erected buildings there is additional water that comes from the fabrication process. As a result of the natural drying process a moisture content state is achieved in the building materials in the course of time that is denoted as the practical water content. [19]

From DIN 4108, Part 4 it is defined as the value that is not exceeded in 90 % of the cases of investigation of satisfactorily dried-out structures. Table 14 lists the practical moisture contents of the most common building materials. However, these should be used exclusively for purposes of orientation.

A further important area in moisture assessment of building materials is the classification of the moisture state of floor screeds. Before a covering, such as parquet for example, can be applied to a floor screed the testing of the moisture content of the screed is absolutely essential. The technical prerequisites must be met such that no damage to the covering is to be anticipated. A check must therefore be made that the screed has an acceptable residual moisture content.

This usually takes place with the aid of the CM method. Material samples are taken from selected points on the screed and the CM value is determined for these. The results now provide information, as a function of the floor covering, as to whether the maximum permissible moisture content for the screed is exceeded or not (see Table 15).

| Cement-bound substrates | |
|--|-------------|
| without floor heating | |
| • Linoleum, textiles | max. 2.5 %* |
| • Plastic, parquet, wood-based materials and laminates | max. 2.3 %* |
| • Rubber, cork | max. 2.0 %* |
| with floor heating | |
| | max. 1.5 %* |
| Conventional anhydrite mortar (calcium sulphate mortar) | |
| without floor heating | |
| | max. 0.8 %* |
| with floor heating | |
| | max. 0.5 %* |
| Anhydrite flowing screeds (calcium sulphate flowing mortar) | |
| without floor heating | |
| | max. 0.5 %* |
| with floor heating | |
| | max. 0.3 %* |
| Wood under-floor | |
| | 7 - 12 %** |
| Chipboards | |
| | 6 - 9%** |
| Fibreboards | |
| | 4 - 7 %** |

* measurement with CM device,
** measurement with wood moisture content measurement device

Table 15-A: Maximum moisture content for readiness for covering (Switzerland)

| Upper floor | Cement screed in CM-% | | Calcium sulphate screed in CM-% | |
|--|------------------------------|-----------------|--|-----------------|
| | heated | unheated | heated | unheated |
| Elastic coverings | 1.8 | 2.0 | 0.3 | 0.5 |
| Textile coverings | 1.8 | 2.0 | 0.3 | 0.5 |
| Parquet and wooden blocks | 1.8 | 2.0 | 0.3 | 0.5 |
| Laminate floors | 1.8 | 2.0 | 0.3 | 0.5 |
| Stone and ceramic coverings in a thick bed | 1.8 | 2.0 | 0.3 | 0.5 |
| Stone and ceramic coverings in a thin bed | 1.8 | 2.0 | 0.3 | 0.5 |

* *Magnesia screed: 1.0 to 3.5 – according to the composition of the organic components, established values are to be obtained from the manufacturer.*

Table 15-B: Maximum moisture content for readiness for covering (Germany)

4.2 Building material moisture content measurement – resistance principle

4.2.1 Measurement principle

The resistance principle has already been dealt with in Section 3.2. The principle is identical for the measurement of building material moisture content. Nevertheless some specific material-related information is once again provided here. As in the case of wood measurements the resistance, or in other words, the conductivity of the material is measured by the measurement device.

The electrical conductivity of a dry mineral building material (e.g. cement screed) is very low. If water is taken in by the sorption processes described above, the conductivity of the material can quickly rise, or in other words the resistance can quickly fall.

In the assessment of the results measured it must be taken into account that the results are affected by the material composition of the material being measured. The presence

of soluble salts can significantly distort the measured result. The higher the level of salts, the higher the measured values. A further influence parameter in the assessment of the results is the connection between the electrodes and the building material.

In the case of porous mineral building materials relatively high interface resistances can arise as a result of poor electrode contact (connection), and these distort the measured results. Here aids such as e.g. contact mass should be introduced.

Both of the points named are responsible for the fact that the accuracy of the measured results in the case of mineral building materials is lower than for wood materials.

Exact statements on the moisture content of materials containing minerals can only be made by applying the kiln-drying method or the CM method.

If however **estimated statements concerning the building material moisture content** are sufficient, then the resistance method should be used, as it is less resource-intensive.

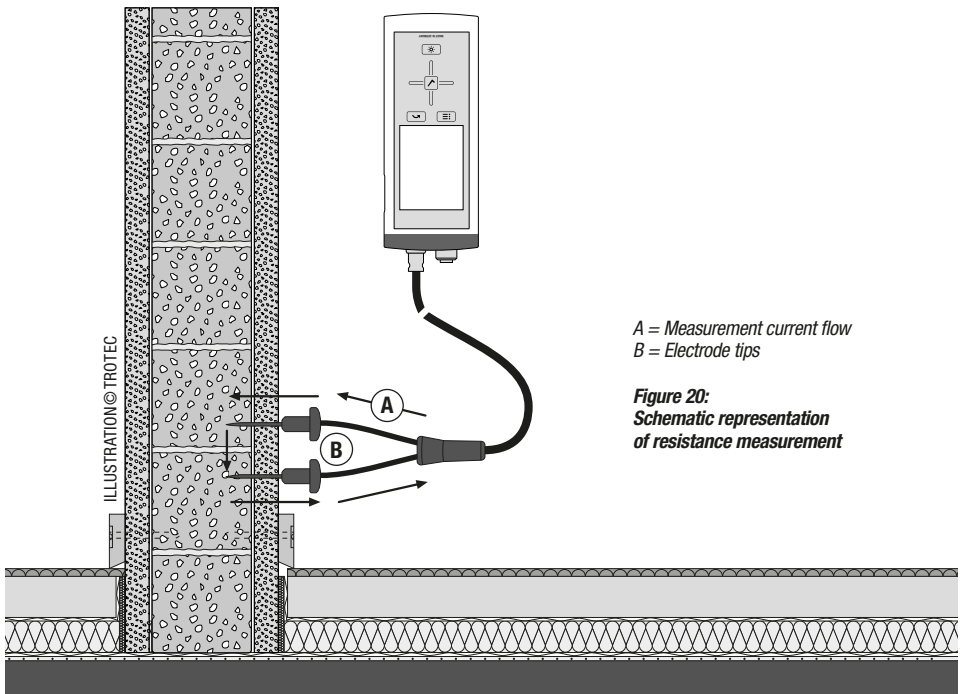

Figure 20:
Schematic representation
of resistance measurement

4.2.2 Electrodes for building material moisture content measurement – operation and measurement procedure

For estimated determination of the moisture content in porous mineral building materials such as roughcast or screed, different designs of passive electrodes can be used according to the field of application, and these exhibit specific advantages and disadvantages.

In the choice of electrode it should be noted that certain parameters must be maintained to obtain as accurate a measured result as possible. For the reasons listed above, particular attention is to be devoted to the connection with the material being measured.



TS 60 hand electrode

The TS 60 hand electrode can be seen as a basic holder that exhibits a defined separation between the electrode tips.

By means of the impact-resistant plastic body the tips can be driven completely into the test piece.

The two hexagonal union nuts also allow replacement of the electrode tips.

The following lengths can be supplied at the present time:

- 20 mm (max. penetration depth 14 mm)
- 30 mm (max. penetration depth 24 mm)
- 40 mm (max. penetration depth 34 mm)
- 60 mm (max. penetration depth 54 mm)

The field of application includes the recording of moisture content in soft building materials such as cement or plaster. In operation care must be taken that the tips are driven into the material being measured to their full length.



TS 20/110 brush electrodes, 7 mm

Each of the two electrodes of the brush electrodes comprises a 110 mm long brush head and an insulated shaft. The field of application is the specific measurement of moisture in a homogeneous building material without using a contact mass. The connection to the goods to be measured is made by the brush head.

In operation the following procedure should be observed:

1. Two holes must be drilled into the homogeneous material being measured, with a separation of approx 10 cm and a diameter of 6 mm. For the drilling process a sharp drill should be used at a low rpm.

2. Remove any debris from the two drilled holes (e.g. by blowing out).
3. After a waiting time of about 10 minutes (to allow the moisture to regain equilibrium) push the electrode brushes in up to the required measurement depth.

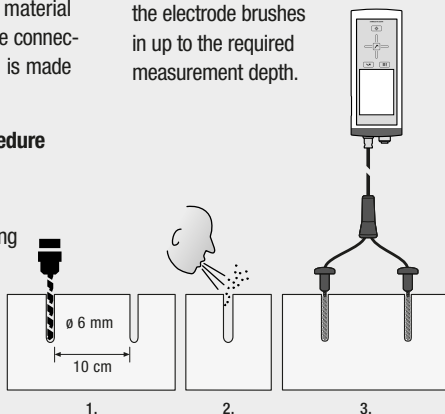

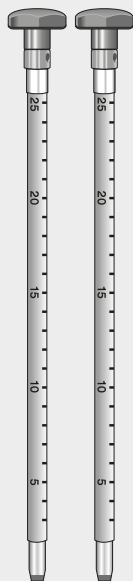

TS 24/250 layer depth electrodes, 8 mm

Each electrode is made up of an electrode tube and an electrode rod.

The field of application is moisture measurement in specific layers in homogeneous building materials using the contact mass.

The material moisture content can be determined according to the length up to a maximum depth of approx. 250 mm.

The electrode tubes are insulated and equipped with a depth scale so that the measured value can be recorded at the desired measuring depth.

In operation the following procedure should be observed (see also “Note on how to handle the contact mass”):

1. Two holes must be drilled into the hard material being measured to the measurement depth, with a separation of approx 10 cm and a diameter of 8 mm. For the drilling process a sharp drill should be used at a low rpm.

2. Remove any debris from the two drilled holes (e.g. by blowing out).

3. After a waiting time of about 10 minutes (to allow the moisture to regain equilibrium) fill the electrode tubes with contact mass. For this purpose push the tip of the electrode tube 30 mm square into the contact mass and fill it with the latter.

Clean the electrode tube up to the tip with a dry cloth and guide it into a drilled hole until it reaches the stop position. Then carry out the same procedure with the second electrode.

4. Guide the two electrode rods into the tubes until pressure is exerted on the contact mass at the end of the drilled hole.

Note on how to handle the contact mass with insertion electrodes or layer depth electrodes:

In production the contact mass is subject to numerous quality checks and in its as-delivered state contains an ideal moisture content for good working properties. It alters its consistency if it is not used for a long time as a result of the reduction in moisture content, and then appears dry and brittle. Working with the material in accordance with the instructions is then no longer possible.

In such cases a simple solution has been proven to work in practice, in which the dried-out material is replenished with the required quantity of water to achieve an even distribution of the moisture content. For this purpose simply introduce some water into the contact mass container and wait for a short time. After this task has been completed the contact mass can be used once again without any problems.

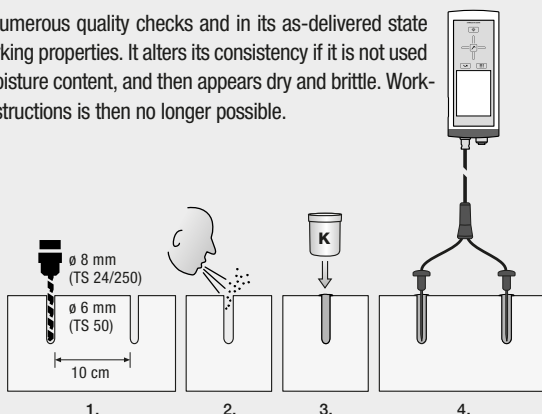

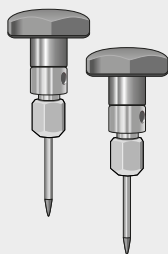

TS 50 insertion electrodes

The two-piece insertion electrode allows a variable separation when positioning the electrode tips.

The two hexagonal union nuts also allow replacement of the electrode tips:

- 20 mm (max. penetration depth 14 mm)
- 40 mm (max. penetration depth 34 mm)
- 30 mm (max. penetration depth 24 mm)
- 60 mm (max. penetration depth 54 mm)

In the basic configuration with the short tips the field of application is in the recording of moisture content for hard building materials such as concrete or cement screed.

In operation the following procedure should be observed (see also “Note on operation using contact mass”):

1. Two holes must be drilled into the hard material being measured, with a separation of approx 10 cm and a diameter of 6 mm. For the drilling process a sharp drill should be used at a low rpm.
2. Remove any debris from the two drilled holes immediately (e.g. by blowing out).
3. After a waiting time of about 10 minutes push the contact mass with the rear face of the drill hard into the drilled hole until the hole is filled.
4. Complete insertion of the electrode tips into the contact mass.
5. The user must take care that only the drilled holes, and not the surface of the material being measured, make contact with the contact mass, since otherwise the measured results obtained are incorrect. The reason for this is the high conductivity of the contact mass.



Measurement procedure

For each measurement the following steps are to be performed:

1. Select electrode(s) depending upon the measurement task and the field of application.
2. Perform the operation and measurement preparations appropriate to the electrodes selected.
3. Connect electrode(s) with the TC 20 cable to the BNC connector plug
4. Switch on the device.
5. Activate measurement method by selection of sensor number 100 (building material moisture content measurement). In the display of the T3000 the current measured value is shown in the display field of sensor 1 without a unit. For a better understanding the user can designate this display value with the unit of digit (digital numerical value).
6. Read off the measured value in the display and extract the comparison value from the diagrams presented in Section 4.2.3.

4.2.3 Compilation of the most important comparison values for assessment of measured results

In order that the measured values can be aligned with the actual moisture contents of a building material, calibration measurements have been performed on selected building materials.

Tables and diagrams been drawn up in collaboration with the Institute for Building Research of the RWTH Aachen University, and these provide the correlations between the measured value and the mass-related moisture content (M.-%) of the building material investigated.

For the systematic calibration of moisture contents test pieces have firstly been manufactured and then impregnated with a calculated volume of water. In the second step the test pieces were then stored for two weeks in special packaging in order to guarantee a homogeneous moisture distribution.

After these two weeks it was possible to carry out the resistance measurements, before using the kiln-drying method. At temperatures specific to each building material the test pieces were dried out until they achieved a constant weight. The moisture content (in M.-%) thus achieved could then be compared with the measured resistance value.

It should be noted that in addition to moisture content and the porosity structure of the test piece the temperature also has a significant influence on determination of the resistance. For this reason one either carries out comparative measurements at constant climatic conditions (in the laboratory), or one relates the measured values obtained to a base temperature. This can be done using an Arrhenius correction function. Here the reference temperature is 23 °C (climatic conditions 23/60).

For the example of C 30/37 concrete the measured characteristics for the temperatures 5 °C, 20 °C and 30 °C are presented graphically for a selected range (see Figure 21).

Thus when taking measurements it must always be remembered that a comparison between the measured resistance value and moisture content is affected by the material temperature. If the material temperature is higher than 23 °C a higher measured value is displayed. If on the other hand the material temperature is lower than 23 °C then the measured value falls also.

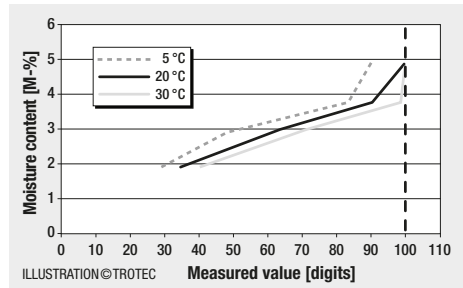
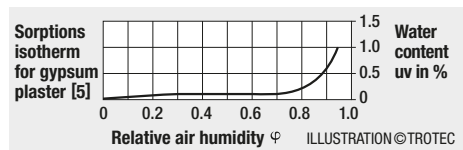

Figure 21: C 30/37 concrete, moisture content as a function of measured resistance value. Graphical presentation of the measurement characteristics at different temperatures (see Figure 22) [18]

Figures 22 to 25 show the measured results in diagrammatic form. These diagrams now allow a comparison between the measured value and the actual moisture content. The selection of diagrams is limited to the most commonly used mineral building materials. The diagrams are related to a reference temperature of 23 °C (climatic conditions 23/60). [18]

Gypsum plaster

Determination of the moisture content for a gypsum plaster requires special attention. As one can see from the following diagram, the volume-related moisture content of gypsum plaster alters little for air humidity values from 0 to 80 %.



Above 80 % the moisture content alters dramatically. This has also been confirmed by calibration measurements taken by the Institute for Building Research [18].

Accordingly we are of the opinion that a direct alignment between measured value and mass-related moisture content is not possible. As a sufficient criterion for classifying the measured values, however, it is true to say that a gypsum plaster can be designated as “dry” if the measured resistance value is less than 30 digits.

In assessment of the values measured it is essential to be aware that different parameters are predominant for each measurement (see Section 4.2.6).

Important influence factors that affect the level of the measured value are the coupling of the electrodes to the material being measured, the material temperature, the building material composition, and the quantity of salts and any additives that may be present.

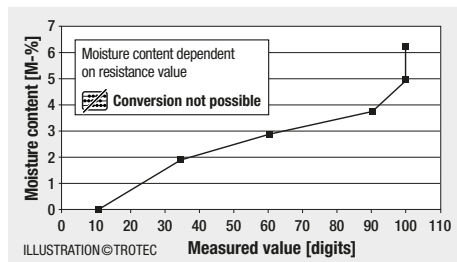

Figure 22: C 30/37 concrete, moisture content as a function of measured resistance value

For materials that are not listed it is generally possible to make sufficiently meaningful statements via local comparative values. Thus in the case of water damage the area that is affected by moisture can be demarcated by means of a comparative measurement carried out on an evidently dry wall or floor surface as a basis for assessment.

From the higher measured values in the area that is being assessed it is then easy to define the extent of the area that is affected by moisture.

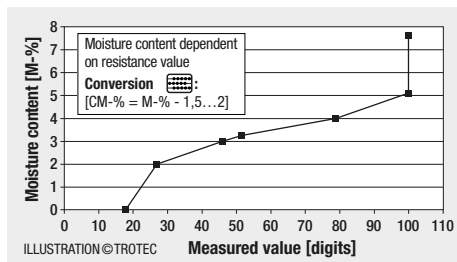

Figure 23: Cement screed, moisture content as a function of measured resistance value

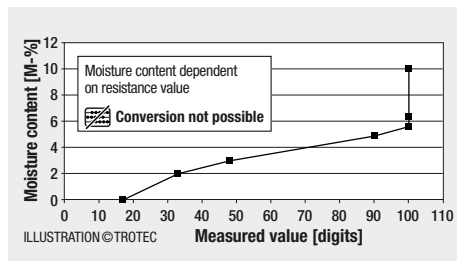

Figure 24: Flowing cement screed, moisture content as a function of measured resistance value

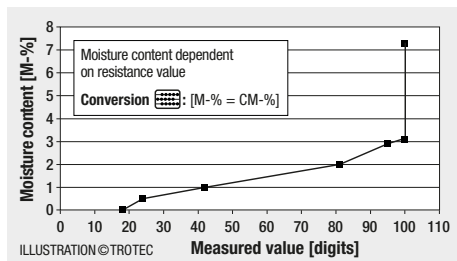
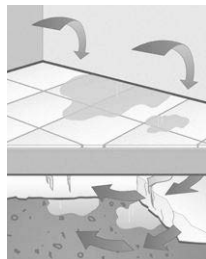

Figure 25: Anhydrite flowing screed, moisture content as a function of measured resistance value

4.2.4 Depth measurements on covered layers of building material



In the assessment of the moisture distribution in building structures the user is often faced with the problem that the damage that is visible is caused by a concealed distribution of moisture. This can occur, for example with a fabricated floor with footstep sound absorption, multi-layer insulated walls, insulated flat roofs or concealed beams in a timbered house (see Figures 26 to 29).

In the case of water damage it can be that the moisture has become distributed in a concealed manner during construction. The water may have spread out in the concealed plane of the insulation and may then have risen upward by means of capillary forces into the walls. However the area of damage that is visible is generally not identical with the actual area of damage.

For such cases the resistance measurement method can be used with electrodes that are specially developed for this purpose. These are so designed that if used correctly the measurement takes place in the concealed layer of building material.

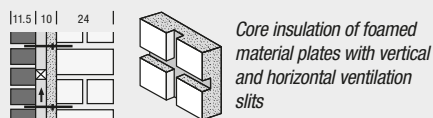

Core insulation of foamed material plates with vertical and horizontal ventilation slits

Figure 26: Two-layer outer wall / core insulation

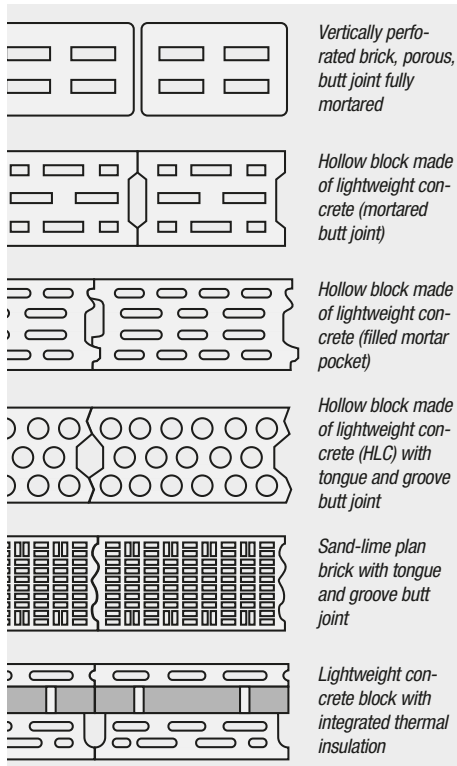

Figure 27: Large-scale blocks for internal and external wall structures

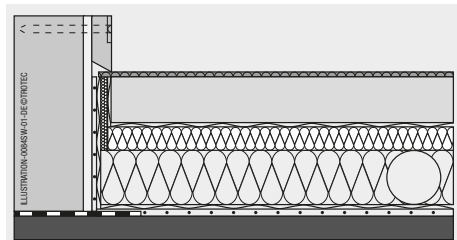

Figure 28: Fabricated floor with footstep sound insulation

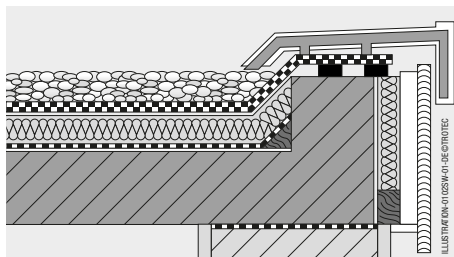
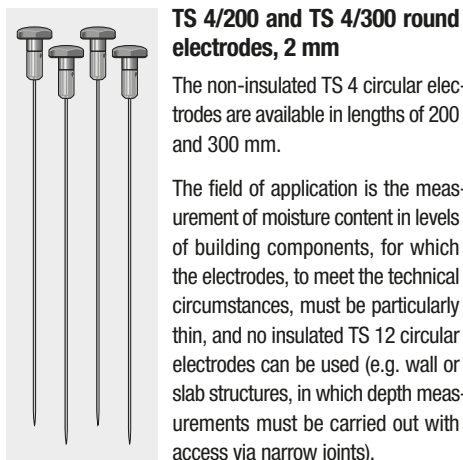

Figure 29: Flat roofs (thermal roof), insulated



TS 4/200 and TS 4/300 round electrodes, 2 mm

The non-insulated TS 4 circular electrodes are available in lengths of 200 and 300 mm.

The field of application is the measurement of moisture content in levels of building components, for which the electrodes, to meet the technical circumstances, must be particularly thin, and no insulated TS 12 circular electrodes can be used (e.g. wall or slab structures, in which depth measurements must be carried out with access via narrow joints).

In principle the insulated circular electrodes should always be used, since thanks to the insulation a definitive measurement can be performed in the required layer of the building component.

In operation the following procedure should be observed:

1. Two holes must be drilled into the building component layers to be investigated, with a separation of approx 10 cm and a minimum diameter of 4 mm.
2. Push the electrodes into the drilled holes and then insert the tips into the material being measured.

Caution: Do not bend the electrodes; otherwise there is a risk of fracturing the electrode shaft because of the low strength of the material!

Take care that no metallic components (e.g. aluminium laminations in the thermal insulation) distort the measured result (see Section 4.2.6.2, Figure 31).

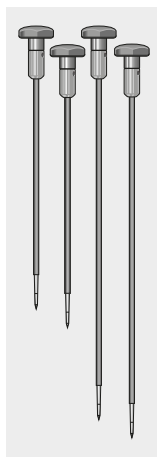

TS 12/200 and TS 12/300 round electrodes, 4 mm

The insulated TS 12 circular electrodes are available in lengths of 200 and 300 mm.

The field of application is the definitive measurement of moisture content in concealed levels of building components where it is absolutely essential that the electrode shaft be insulated. Absence of insulation would falsify the measured result.

From experience the most frequent use is in the determination of moisture content distribution in multi-

layered wall or slab structures such as floating screeds, multi-layered walls, wooden beam ceilings, thermal roofs, etc (see Figures 26 to 29).

In operation the following procedure should be observed:

1. Two holes must be drilled into the building component layers to be investigated, with a separation of approx 10 cm and a minimum diameter of 6 mm.
2. Push the electrodes into the drilled holes and then insert the tips into the soft material being measured (e.g. footstep sound insulation, or thermal insulation).

Take care that no metallic components (e.g. aluminium laminations in the thermal insulation) distort the measured result (see Section 4.2.6.2, Figure 31).

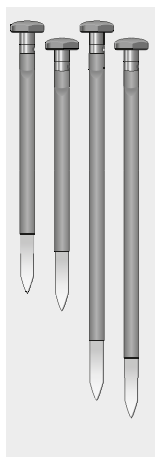
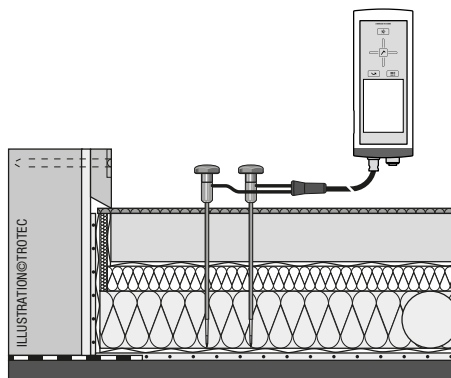

TS 16/200 and TS 16/300 flat electrodes, 1 mm

The insulated TS 16 flat electrodes are available in lengths of 200 and 300 mm.

The field of application corresponds to the intended use of the insulated TS 12/200 and TS 12/300 circular electrodes.

The advantage of the flat electrodes lies in the fact that there is no need to drill holes in the surface, and that the electrodes can simply be introduced through the edge strips by removing the base.

In operation the following procedure should be observed:

1. Insert the electrodes via the edge insulation strips of the fabricated floor until the electrodes cannot be inserted any deeper.
2. Pull them out again by about 1 cm.

Take care that no metallic components (e.g. aluminium laminations in the thermal insulation) distort the measured result (see Section 4.2.6.2, Figure 31).

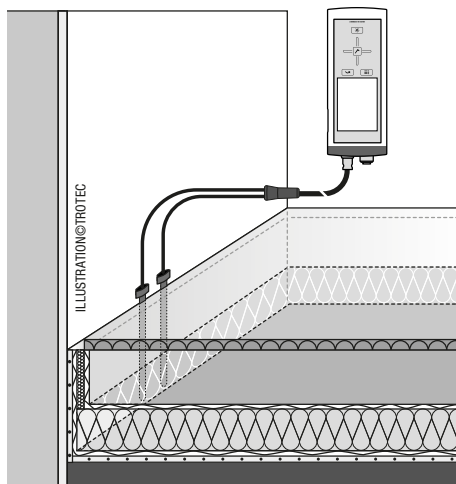

4.2.5 Comparative values for the assessment of water-damaged areas

In the event of water damage the resistance measurement can be used to undertake an assessment of the area that has to be dried.

On the basis of the practical moisture content and the variable parameters (see section 4.2.6) the necessity for a technical drying procedure can be assessed with the aid of Table 16.

Here it is essential to note that the measured results are only one component in a comprehensive diagnosis of the damage. The experience of the person carrying out the assessment and the local circumstances play just as important a role as the documentation of the measured results. The success achieved with a technical drying procedure can also be recorded via the documentation.

| | Digit scale values | Dry* | Boundary region** | Severe moisture penetration*** |
|----------------------------|---|------|-------------------|--------------------------------|
| Building materials | Anhydrite, cement, wood cement screed | < 36 | 36 - 50 | > 50 |
| | Stone wood | < 41 | 41 - 55 | > 55 |
| | Gypsum plaster | < 31 | 31 - 40 | > 40 |
| Insulating layers / infill | Polystyrene (foam particles, polystyrene rigid foam (extruded), polyurethane rigid foam | < 36 | 36 - 50 | > 50 |
| | Glass fibre, stone or slag wool | < 36 | 36 - 45 | > 45 |
| | Silicate cellular glass | < 36 | 36 - 50 | > 50 |
| | Cork, porous volcanic rock | < 31 | 31 - 40 | > 40 |
| | Wood wool light construction sheets | < 41 | 41 - 50 | > 50 |
| | Loam infill | < 41 | 41 - 55 | > 55 |
| | Coconut fibre | < 36 | 36 - 40 | > 40 |

* no drying out procedure required;
 ** drying out may be necessary after assessment of the damage characteristics;
 *** technical drying out procedure required;
 all values are approximate values and no responsibility is taken for their correctness

Table 16: Orientation values for the assessment of building material moisture content

4.2.6 Interference effects and instructions to be followed for resistance measurements

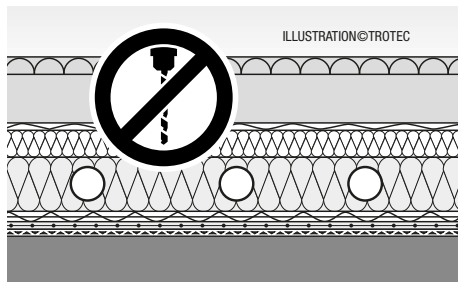

Figure 30: To avoid damage no drilling of holes may be carried out without previous detection of circuits and pipework.

In order to achieve measured results that are as accurate as possible, it is important to understand the interference effects that can generally arise. From the measurement principles described above and the specific material properties the following instructions for the resistance measurements emerge:

- Check before drilling each hole, whether electrical circuits or water pipework have been laid in the area where the hole is to be drilled.

For the rapid non-destructive detection of circuits and pipework we recommend the use of suitable measurement devices. You can find an overview of appropriate units on the Internet on www.trotec.com.

- In the case of hard mineral building materials the contact between the electrodes and the building material must be guaranteed by using a contact mass, since only in this way can the interface resistance between the electrodes and the building material be held low.
- The temperature of the building material should lie in the region of 20 °C for the moisture content measurement.
- Ensure that the electrodes are always fully insulated without any defects. In the event of insulation that is missing or damaged it is not possible to carry out any definitive depth measurement.

The measurement device always shows the value of the lowest resistance. The measured resistance could therefore be recorded in another plane, and not at the tips of the electrodes as required. A false interpretation of the results would be the consequence.

Practical tip:

Damaged insulation can be replaced by commercially available heat shrink tube, so there is no need to procure a new pair of electrodes.

- In order to avoid damage to the insulation of the electrode pairs, avoid pushing them through hard materials such as gypsum plasterboard, for example. If this is not possible two holes (diameter larger than that of the measurement electrodes) should be drilled into the separation plane.
- When the actual measurement is being carried out, the electrodes should not be held in the hand. It is advantageous if the measurement cables, the measurement device and the electrodes are not moved while the measured value is being read off.

4.2.6.1 Interference effects caused by electrically conducting salts in the building material

A separate section is devoted at this point to the interference effects caused by salt, since structural moisture problems often occur in combination with water-soluble salts.

Salts improve the electrical conductivity of a building material to a significant extent. The result obtained using the resistance measurement method is distorted in that too high a measured value is displayed.

Salts ionise if they go into solution; this means that the differently charged components (ions) of the dissolved salt crystal move apart.

If the moisture content of a building material that contains water with dissolved salts is measured one is applying a voltage to the salt solution via the electrodes. The positive ions of the salts move across to the negative electrode, while the negative ions move across to the positive electrode.

The ions give up their charges to the electrodes, and this process corresponds to a flow of current.

This additional current flow adds to the measurement current with the result that the measurement current and correspondingly the value measured appear to be higher. The higher measurement current is interpreted by the measurement device as a lower resistance and thus as a higher measured value.

4.2.6.2 Interference effects caused by electrically conducting materials

If a building material or a multi-layer wall or floor slab structure contains an electrically conductive material this produces a lower resistance value that can be mistaken for high moisture content values. This leads to incorrect measurement values being displayed.

Generally speaking it is not possible to detect from a visual check whether electrically conducting materials are present in the structure.

The largest sources of error here include, in particular, reinforcements, metal laminations and conducting insulation materials such as slag infills in wooden beamed ceilings. In particular in the case of insulation materials with metal laminations incorrect interpretations of the results measured occur time and again when the resistance measurement method is used.

To illustrate this problem Figure 31 shows three examples of application of the resistance measurement method to insulation layers with metal laminations.

Application example 1:

Use of non-insulated electrodes; the measurement current flows via the metal foil on the upper surface of the insulation layer. The value measured is false.

Application example 2:

Use of insulated electrodes; point of measurement on the PVC film; the measurement current flows via the metal foil on the lower surface of the insulation layer. The value measured is false.

Application example 3:

Use of insulated probes that have not been fully inserted. The measurement current flows via the insulation layer. The measurement current corresponds to the electrical resistance of the insulation layer.

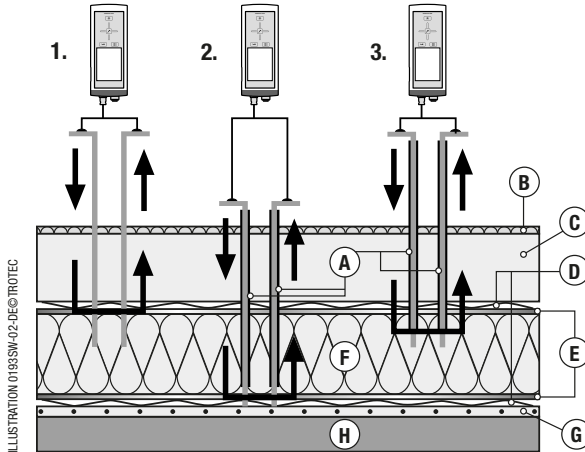

- A: Insulating covering
- B: Carpet
- C: Screed
- D: PE film
- E: Metal lamination
- F: Insulation layer
- G: PVC film
- H: Concrete deck

Figure 31:
If the electrically conducting metal layer makes contact with the signal transmitter it is mistaken for total water penetration.

4.3 Building material moisture content measurement – capacitive method

In addition to the resistance measurement principle the T3000 provides the option of determining the building material moisture content using the capacitive measurement principle. This method is also an indirect method, since it is not the water content that is determined, but rather the dielectric material properties that are registered.

This method exhibits particular advantages in providing qualitative statements, if rapid non-destructive measurement results are required. **Quantitative statements with regard to building material moisture content are not possible in practice with the capacitive measurement method.**

4.3.1 Measurement principle

The capacitive measurement method is non-destructive, since the dielectric constant " ϵ " of the building material is determined via the high-frequency field of a capacitor.

The dielectric constant is, like the electrical resistance, a property of building materials whose value alters if the material takes in moisture.

Schematically a capacitor is normally shown as two plates made from an electrically conducting material. These plates are located opposite to each other, but may not touch each other.

If a voltage is introduced across these plates, one of the plates becomes positively charged, while the other plate becomes negatively charged. An electric field forms between the plates, which, when it has achieved its full strength, remains constant. [2]

In the TS 660 SDI sensor the measurement field forms between the active spherical head and the substrate that is to be assessed (see Figure 32).

This ability to store energy in the electric field of a capacitor is known as capacitance. The larger the area of the capacitor plates and the smaller the separation between the plates, the higher is the capacitance of the capacitor.

In addition the capacitance is also dependent on the material that separates the plates. This separating material is called the dielectric. The dielectric alters the capacitance of the capacitor although it does not conduct any current.

The value of the dielectric number is a ratio, and defines by how many times a material increases the capacitance of the capacitor compared with air.

Water has a dielectric constant that is about 80 times larger than that of air ($\epsilon = 1$) and is at least 10 times larger (ϵ about 2 to 8) than that of a mineral building material.

Accordingly it is very easy to detect water in building materials. The higher the moisture content of the building material, the larger is the resulting dielectric constant.

Using a high-frequency alternating current, the measurement device thus measures the capacitance of the spherical head capacitor, which is affected exclusively by the variable dielectric constant.

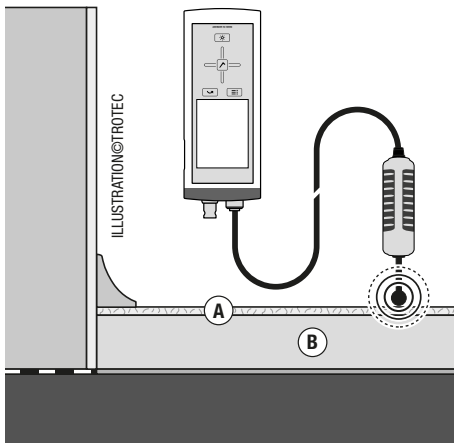

A: Tiles, carpet, PVC, B: Screed

Figure 32: Schematic representation of capacitive measurement with the T3000.

4.3.2 The TS 660 SDI sensor for building material moisture content measurement – measurement procedure and operation



In contrast to the building material moisture content measurement using the resistance method the TS 660 SDI is used in the capacitive method of measurement. The advantage of the sensor lies in its non-destructive recording of the building material moisture content.

The building material moisture content sensor essentially comprises a spherical head and a shaft that exhibits a well-defined surface by which it can be held.

The field of application of the sensor lies in the determination of moisture distributions near the surface in building components and building materials.

The measured values are to be interpreted as relative values, since by means of the method of measurement described above it is purely a difference between dry and moist building materials that can be discerned.

This is based on the fact that the bulk density of the building material has an immediate effect on the dielectric constant.

The measured value displayed increases with increasing density of the building material and correspondingly falls with a lower building material density.

Comparison measurements are carried out on similar materials by firstly measuring on a wall or floor surface that is evidently dry; the value obtained forms the dry reference value.

If the measured values at subsequent measurement positions are then substantially higher, it can be assumed that at these positions there is a higher level of moisture penetration in the area close to the surface.

The diagrams presented in Section 4.3.4 can therefore only be called upon for orientation purposes. The measurement results presented there have been determined under clearly defined parameters and for known material components.

Practical tip:

In the run-up to a CM measurement it is possible, using the capacitive method, to localise zones of moisture near the surface quickly and simply. Then, according to the task in question, representative samples can be taken for the CM measurement.

In operation the following points are to be noted:

1. The main use lies in comparative measurements on the same building material or similar components. From the value displayed moisture zones near the surface can be demarcated. The measurement is also suitable for surveys of water damage and for location of leakages.

This is particularly true for tiled surfaces on which there is apparently no direct water penetration that can be identified. Tiles do not allow water penetration to the surface, even if they are about to separate from the wall.

2. The depth of penetration of the measurement field is 2 to 4 cm, depending on the bulk density and the building material moisture content.
3. The sensor may neither be fixed in the locking slit of the measurement unit, nor the sensor grip held too high up (see Figure "Wrong/Right"). In both cases too high a measured value would be displayed.
4. Place the sensor down as nearly at right-angles to the material being measured as possible. To avoid measuring errors, maintain a minimum distance of 8 to 10 cm from the corner regions.



Measurement procedure

If an estimation of the moisture distribution near the surface of mineral building materials is to be performed, the following basic work steps must be performed:

1. Connect the TS 660 SDI sensor with the TC 30 SDI connection cable to the measurement unit.
2. Switch on the device.
3. Setting measurement method in the T3000.
4. Performing a function check. Hold the sensor at the grip and hold up in the air. The sensor calibrates itself; calibration is confirmed by a several acoustic signals. The displayed value should be between 0 and 5 digits, otherwise the sensor is not calibrated accordingly (see operating instructions chapter 6.8).
5. Press the spherical head of the sensor hard down onto the surface of the material and align the shaft at right-angles to the surface.
6. In the display of the measurement device the current measured value is shown in the display field of sensor 1 without a unit. For a better understanding this display value is to be understood as a digit (digital numerical value).
7. Read off the measured value in the display and determine the comparison value from the diagrams presented (see Section 4.3.4).

Practical tip:

With the TS 660 SDI the alarm function of the T3000 can also be brought into play.

Advantage: *With the alarm limit value sensor, large areas can also be measured quickly and effectively. The user can concentrate on the target without having to watch the measured values all the time on the display.*

As soon as the preset limit value is exceeded, the TS 660 SDI sensor alerts the user with an acoustic signal!



The alarm function makes possible an unconventional and extremely effective mode of use for area measurements:

Here the measurement device is held such that the TS 660 SDI sensor on the connected TC 30 SDI cable makes contact at nearly at right-angles as possible to the floor.

Now the sensor can be held beside the user as he walks over the area to be measured. If the defined limit value is exceeded the sensor alarms the user.

It is probably not possible to carry out measurement of an area any faster than this!

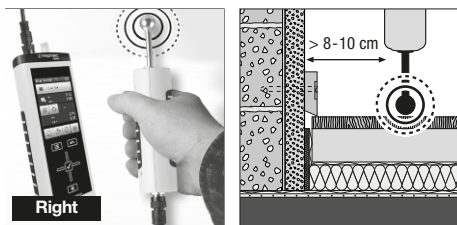

4.3.3 Interference effects and instructions to be followed for the capacitive measurement method

From the measurement principle as described above important instructions emerge for the field of application of the TS 660 SDI building moisture content sensor:

- The measurement results should be exclusively used for orientating humidity measurements. It is only possible to draw conclusions as to absolute moisture content in M-% in the case of measurements that have been taken with the same parameters and building material compositions. **The determination of readiness for covering is therefore not possible in practice.**
- When switching on the sensor, this must display a value of 0 when held in the air. Otherwise the sensor is not correctly calibrated. A single-point calibration must then be performed in accordance with Section 6.8 of the operating instructions.
- Before taking measurements any contaminants must be removed from the surface of the mineral building material (e.g. paint residues, dust).
- If metal is contained in the test piece (e.g. electrical circuits, pipes, reinforcement, plaster holders), the value measured rises dramatically. In the case of dry building materials a measured value of more than 90 digits can be classified as an indication of the presence of metal.
- If the spherical head is held in corners, the measured value is basically higher since there is more material in the radiation field of the measuring head. A distance of more than 8 to 10 cm from the corner should be maintained.
- The spherical head must always be held perpendicular to the material being measured during the measurement and not tilted.

- Always press the spherical head hard down on to the surface to be measured.
- Rough surfaces will always show a measured value that is too low. For a test piece made out of conventionally vibrated C30/37 concrete the Institute for Building Research at the RWTH Aachen University was able to determine a difference in the measurement of 10 digits. [18]
- The depth of penetration with the TS 660 SDI sensor lies at between 2-4 cm according to the bulk density and the building material moisture content. It is not possible to draw any conclusions concerning zones at greater depths.

4.3.4 Compilation of the most important comparison values for assessment of measured results

In order that the capacitive measured value trends can be aligned with the actual moisture contents of a building material, calibration measurements have been performed on selected building materials.

Tables and diagrams have been drawn up in collaboration with the Institute for Building Research of the RWTH Aachen University, and these provide the correlations between the measured value and the mass-related moisture content (M.-%) of the building material investigated.

For systematic calibration of moisture contents, test pieces have firstly been manufactured and then impregnated with a calculated volume of water. In the second step the test pieces were then stored for two weeks in special packaging in order to guarantee a homogeneous moisture distribution. After these two weeks it was possible to carry out the capacitive measurements (together with the resistance measurements), before using the kiln-drying method.

At temperatures specific to each building material the test pieces were dried out until they achieved a constant weight. The moisture content (in M.-%) thus achieved could then be compared with the measured capacitive value.

It should be noted that the **spread** of the recorded measurement results in the **capacitive method** is disproportionately **larger** than is the case with the resistance method.

The test pieces featured, amongst others, a smooth upper surface and a rough lower surface. Although the test pieces exhibited a homogeneous moisture distribution it was possible to determine measured values on the rough surface that were up to 10 digits lower than those on the smooth surface.

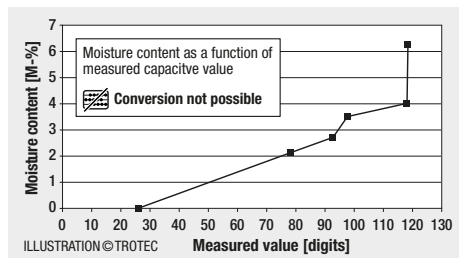

Figure 33: C 30/37 concrete

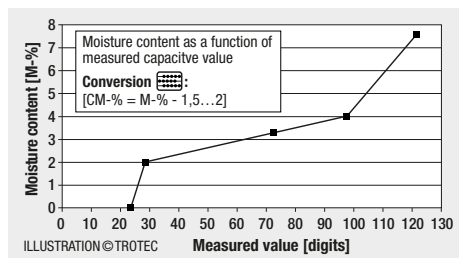

Figure 34: Cement screed

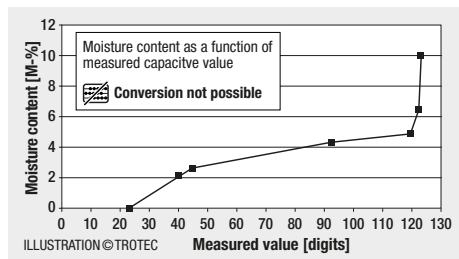

Figure 35: Flowing cement screed

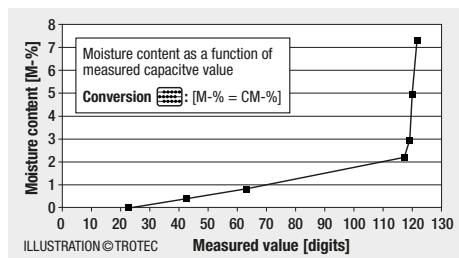
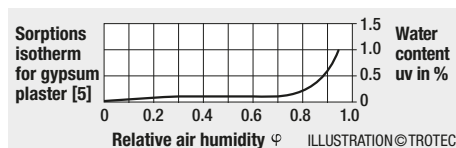

Figure 36: Anhydrite flowing screed

Figures 33 to 36 show the measured results in diagrammatic form. These diagrams now allow a comparison between the capacitive measured value and the actual moisture content. The selection of diagrams is limited to the most commonly used mineral building materials.

Gypsum plaster

Determination of the moisture content for a gypsum plaster requires special attention. As one can see from the following diagram, the volume-related moisture content of gypsum plaster alters little for air humidity values from 0 to 80 %.



Above 80 % the moisture content alters dramatically. This has also been confirmed by calibration measurements taken by the Institute for Building Research [18].

Accordingly we are of the opinion that a direct alignment between measured value and mass-related moisture content is not possible. As a sufficient criterion for classifying the measured values, however, it is true to say that a gypsum plaster can be designated as “dry” if the dielectric value measured with the capacitive method is less than 40 digits.

In the assessment of the measured values it is essential to be aware that different parameters are predominant for each measurement (see Section 4.3.3).

Important influence factors that affect the level of the measured value are the surface texture, the building material composition and the bulk density.

For materials that are not listed it is generally possible to make sufficiently meaningful statements concerning local comparative values. Thus in the case of water damage

| Display T3000 | Building material moisture range |
|----------------|----------------------------------|
| < 40 digits | Dry |
| 40 - 80 digits | Damp |
| > 80 digits | Wet |

Table 17: Measured value indicator for the building material moisture

the area that is affected by moisture can be demarcated by means of a comparative measurement carried out on an evidently dry wall or floor surface as a basis for assessment. The building materials can be classified as tending

to dry or wet according to Table 17. From the higher measured values in the area that is being assessed it is then easy to define the extent of the area that is affected by moisture.

4.4 Building material moisture content measurement – hygrometric method

4.4.1 Measurement principle

The hygrometric measurement of moisture content is a non-destructive, indirect measurement method, which is also known as the **air humidity equilibrium method**.

The principle of the measurement method is the property that mineral building materials interact with the surrounding air. If the relative humidity of the surrounding air increases then the moisture content of the building material increases also. After a certain period of time a state of moisture equilibrium is attained, in which the porous building material exhibits a certain quantity of water.

By means of the sorption isotherm it is now possible to represent the water content “u” (M.-%) as a function of the relative air humidity φ (% r.h.). Since the sorption isotherm strongly depends upon the distribution of pore sizes in the building material, it is also dependent on the composition of the building material. For the building material that is to be assessed there must therefore be a known sorption isotherm.

By the indirect measurement technique it is possible to determine the moisture content of the building material by means of the measurement of the relative air humidity in the structure. The sorption isotherm is selected, and then, using **“air humidity”** as the input quantity, the mass-related moisture content of the building material is determined (Figure 37).

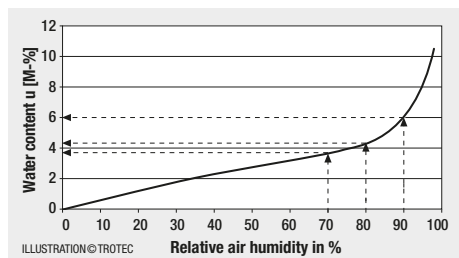

Figure 37: Example of determination of the water content according to the hygrometric method by means of the sorption isotherm.

4.4.2 Hygrometric building material moisture measurements in the drilled hole

Before the hygrometric moisture measurement is used the purpose of the exercise should be established.

On the one hand using the indirect method it is possible to determine the actual moisture content of the building material in M.-%. The basic prerequisite for this is the existence of a suitable sorption isotherm with the help of which the actual water content of the building material that is being measured can be inferred. Here allowance should be made for the fact that for mineral building materials there is a large spectrum of possible sorption isotherms that depend upon the bulk density, amongst other factors.

On the other hand correct usage is able to establish the readiness of concretes to be covered. In practice this is only possible to a limited extent for screeds because of the different bulk densities and working techniques (compaction), even for the same types of screeds, small layer thicknesses, etc.

4.4.2.1 Moisture content measurement in screed

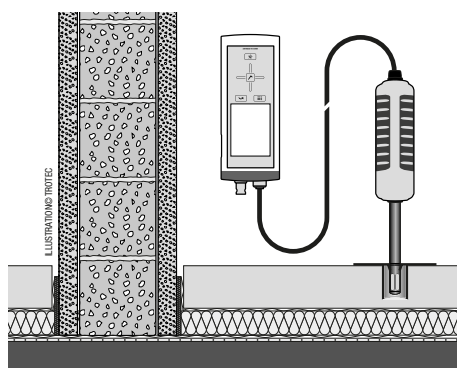

In the rooms in which the points of measurement are located the room climate should not significantly alter for at least

48 hours before the measurement in order to achieve an equilibrium with the building material layer. Any follow-up measurements should be carried out in the same manner.

Execution of the measurement

1. A sufficiently large hole must be drilled to the required depth into the material being measured. For the drilling process a sharp drill should be used at a low rpm.
2. Remove any debris from the drilled hole (e.g. by blowing out) and then introduce a sleeve into the hole that is closed on all sides and only open at the bottom.

For moisture content measurements in screed a sleeve of this kind must always be used, so that the only moisture that enters into the hole void comes from the required depth of layer (at the bottom of the sleeve). Moisture content measurements without a sleeve would create a false "micro moisture profile" and generate misleading measured values.

3. After inserting the sleeve seal the drilled hole so that it is airtight, using adhesive tape or other suitable means.

4. As a result of the heating of the drilled hole a waiting time of at least 15 minutes should be observed to allow stabilisation of the air humidity.
5. Cut into the adhesive tape used to seal the drilled hole (Figure 38 a), so that the TS 210 SDI or TS 250 SDI climate sensor can be introduced into the drilled hole.

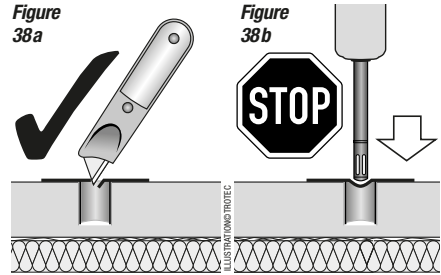

Important: Correct use of the sensors is limited to just the taking of the measurements. **Never try to push through the adhesive tape with the sensor head (Figure 38 b), but instead use means that are suitable for this purpose (knife, etc).**

ILLUSTRATION ©TROTEC

Figure 39:
Sorption isotherms for various materials:

- 1 Anhydrite screed
- 2 Cement screed
- 3 Cement concretes
- 4 Artificial stones
- 5 Plasters

[15]

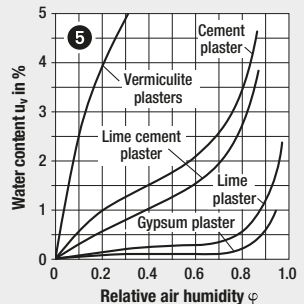
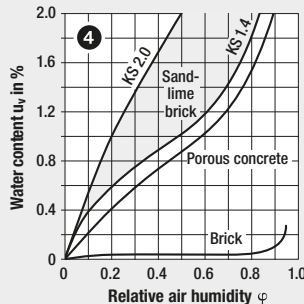
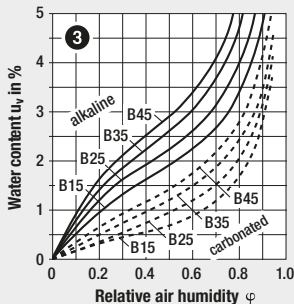
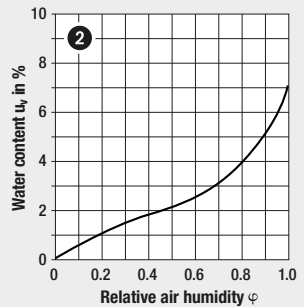
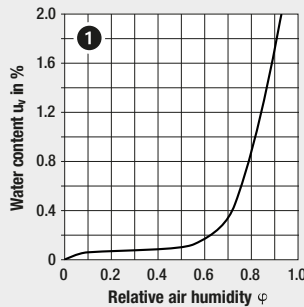

6. After the equilibrium moisture content has been established in the hole void (generally after 30 minutes) the relative air humidity can be read off from the measurement device. By means of the appropriate screed sorption isotherm the water content can now be read off from the diagram via the relative humidity (Figure 39, 1 and 2). It must be noted that the value determined represents simply a single value for the water content at this depth. This does not correspond with the value measured by means of the kiln-drying method, which corresponds to the water content of the whole sample.

Warning: Sensor and structure temperatures must be approximately the same in order to avoid measurement errors. If the sensor is colder than the temperature in the drilled hole the moisture can condense onto the sensor, leading to false measurement results. This fact is particularly significant in the case of heated screeds.

In addition to this **single measurement repeated measurements are to be taken, to check the drying-out characteristics**, the drilled hole can be sealed airtight once again after each measurement with an undamaged strip of adhesive tape.

4.4.2.2 Moisture content measurement in concrete

In contrast to moisture content measurements in screed or walls, the hygrometric moisture content measurement in concrete structures is affected by other parameters, something that determines the measurement procedure correspondingly. This depends on the one hand on the larger thicknesses of layers, and on the other hand, on whether the concrete can be dried from one or both faces.

In practice however the requirement is usually that the user should be able to estimate, as early as possible, whether/when the concrete is in a state in which subsequent building components, such as coatings, can be laid down. For this purpose one must know what kind of moisture content or moisture profile is present after application of an insulating layer through which no water vapour can diffuse, in order to be able to guarantee long-term durability.

Concrete structures that are dried out from one face

In concrete structures that can only be dried out from one face (Figure 40), the moisture content is highest on the side that is opposite to the open face. From experience

the moisture content after application of a vapour-tight covering adjusts to the value that was present at a depth of 40 % of the concrete layer, measured from the open face, before application of the covering (Figure 40) [17].

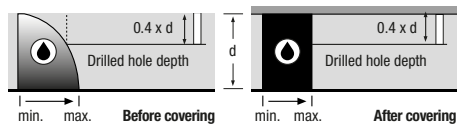

Figure 40: Moisture content profiles for a concrete structure dried out from one face, before and after covering

Concrete structures that are dried out from both faces

In structures for which the concrete can be dried out from both faces (Figure 41), the moisture content during the drying out period is highest in the middle of the structure. From experience the moisture content after application of a vapour-tight covering adjusts to the value that was present at a depth of 20 % of the concrete layer, before application of the covering (Figure 41) [17].

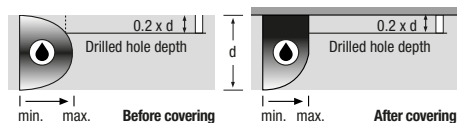

Figure 41: Moisture content profiles for a concrete structure dried out from both faces, before and after covering

The drying out method can however be affected by several factors, which also have an influence on the moisture content profile in the structure.

As a result of such factors the moisture content profiles can alter from those shown above. For this reason the moisture content measurement should always take place at a number of different measurement locations.

Execution of measurements

In the rooms in which the points of measurement are located the room climate should not significantly alter for at least 48 hours before the measurement in order to achieve an equilibrium with the building material layer. Any follow-up measurements should be carried out in the same manner.

1. A sufficiently large hole must be drilled to the required depth into the material being measured. For the drilling process a sharp drill should be used at a low rpm.

2. Remove any debris from the drilled hole (e.g. by blowing out) and then introduce a sleeve into the hole that is closed on all sides and only open at the bottom. For moisture content measurements in concrete a sleeve of this kind must always be used, so that the only moisture that enters into the hole void comes from the required depth of layer (at the bottom of the sleeve). Moisture content measurements without a sleeve would create a false "micro moisture profile" and generate misleading measured values.
3. After inserting the sleeve seal the drilled hole so that it is airtight, using adhesive tape or other suitable means.
4. In the case of concrete structures the equilibrium moisture content in the drilled hole is achieved after 72 hours, and only then can moisture content measurements be taken. [17]
5. After 72 hours have elapsed the adhesive tape used to seal the drilled hole is to be pierced and the TS 210 SDI climate sensor is to be introduced into the drilled hole.

Wait for 10 to 20 minutes. The relative air humidity can then be read off from the measurement device.

By means of the appropriate concrete sorption isotherm the water content can now be read off from the diagram via the relative humidity (Figure 39). It must be noted that the value determined represents simply a single value for the water content at exactly this depth. This does not correspond with the value measured by means of the kiln-drying method, which corresponds to the water content of the whole sample.

Warning: Sensor and structure temperatures must be approximately the same in order to avoid measurement errors. If the sensor is colder than the temperature in the drilled hole the moisture can condense onto the sensor, leading to false measurement results.

In addition to this **single measurement repeated measurements are to be taken, to check the drying-out characteristics**, the drilled hole can be sealed airtight once again after each measurement with an undamaged strip of adhesive tape.

4.4.2.3 Moisture content measurement in tiled wall or floor areas

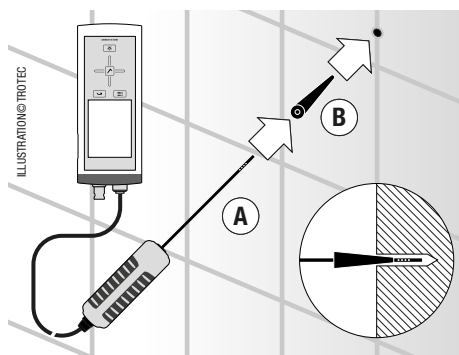

1. A sufficiently large hole must be drilled to the required depth at the point where the tile joints cross. For the drilling process a sharp drill should be used at a low rpm. If in the wall or floor regions affected there are already drilled holes present, (e.g. shower taps, hand towel holder, etc), these can alternatively be used. Drilled holes that are present but too small should be drilled out appropriately.
2. Remove any debris from the drilled hole (e.g. by blowing out) and then by use of an adhesive strip or other suitable means seal the hole in an airtight manner.

3. As a result of the heating of the drilled hole a waiting time of at least 15 minutes should be observed to allow stabilisation of the air humidity.

4. Since as a result of the cylinders used for measurements at points where tile joints cross only sensors with correspondingly narrow sensor head diameters can be introduced, use of the TS 250 SDI climate sensor (A) is recommended. Place the sealing cylinder (B) on the sensor head.

5. Remove the adhesive tape used to seal the drilled hole and introduce the cylinder with the sensor head into the drilled hole. The sensor head must be located at least four centimetres into the structure.

Important: Correct use of the TS 250 SDI climate sensor is limited to just the taking of the measurements.

Never bend the sensor head or force the head into the drilled hole in the case of wall measurements!

6. After the equilibrium moisture content has been established in the hole void (generally after 20 to 40 minutes) the relative air humidity can be read off from the measurement device. **Warning:** Sensor and structure temperatures must be approximately the same in order to

avoid measurement errors. If the sensor is colder than the temperature in the drilled hole the moisture can condense onto the sensor, leading to false measurement results.

If in addition to this **single measurement repeated measurements are to be taken, to check the drying-out characteristics**, the drilled hole can be sealed airtight once again after each measurement with an undamaged strip of adhesive tape.

4.4.2.4 *Moisture content measurement in combination with CM measurements (patent applied for)*

The following statements are taken from a patent application made by the company Dr. Radtke CPM Chemisch-Physikalische Messtechnik AG, Hasenbühlweg 9, CH-6300 Zug/Switzerland. There exists a patent licence agreement between the Trotec company and Dr. Radtke CPM Chemisch-Physikalische Messtechnik AG.

The combination moisture content measurement uses two fundamentally different moisture content measurement methods on the same material sample. On the one hand the method of the corresponding equilibrium moisture content measurement, and on the other hand the carbide method.



Here both material measurements take place in a **single closed system**, which is also the pressure vessel used for the CM measurement.

In the first step the moisture equilibrium is achieved in the pressure vessel and the air humidity in the interior of the vessel is determined using the TS 210 SDI air humidity sensor.

In the second step the carbide ampule is introduced and a CM measurement is performed using the same material sample.

Since both measurement results have been obtained from the same material sample this new method of combination moisture content measurement

leads to greater reliability for the person laying the floor. The additional time required compared with a CM measurement is less than 10 minutes. As a result of the additional reduction in size of the material sample the following CM measurement can take place more quickly.

For determination of the two measurement results a material sample, which has previously been weighed, as required for the following CM measurement, is introduced together with the steel spheres into the pressure vessel, and the latter is closed with a special cover.

The material sample is broken up into small pieces by the steel balls in the pressure vessel. The breaking up process produces a larger surface area for the material sample, as a result of which the “interior air-material sample” moisture equilibrium can be achieved more quickly.

To this end the pressure vessel is held upright and shaken for one minute with as much force as possible. After the shaking process the pressure vessel is then rolled backwards and forwards several times between the palms. In this way intensive contact between the material sample and the internal air is achieved. The “breaking up-rolling” procedure is repeated a second time.

After moisture equilibrium has been achieved the TS 210 SDI air humidity sensor is introduced into the closed system through a sealable opening in the special cover that has been designed especially for the sensor, without any significant loss of moisture as a result. The air humidity and temperature are read off and recorded.

After determination of the corresponding equilibrium moisture content the CM measurement is then carried out. For this purpose the special cover is removed, a carbide ampule is introduced into the pressure vessel, which is held at an angle, and the latter is then without any delay sealed once again with the gauge cover. The pressure vessel is once again held upright while shaken on two occasions for one minute each with as much force as possible. Measurements are then taken in accordance with the procedure described in the operating instructions for the CM equipment.

By the combination of these two methods a correlation of the equilibrium moisture content is possible. Further information concerning the combination moisture content measurement procedure can be obtained from the manufacturer of the CM equipment.

4.4.3 Values obtained from experience in the assessment of building material moisture content with regard to readiness for covering

Since the hygrometric measurement method is especially suited for the rapid non-destructive assessment of screeds and concretes, a number of values obtained from experience are provided in Table 18a.

The measurement method has already been used for a long time in Scandinavia, the USA, and in the Anglo-Saxon countries for the rapid and non-destructive assessment of moisture content values. It is recognised and has proved itself in practice [17]. In some cases other air humidity limits apply, rather than those given in Table 18a.

A further advantage lies in the option of being able to carry out repeat and checking measurements at the same location without additional resource.

Also the determination of moisture content profiles is possible in a simple and rapid manner by the use of different drilled hole depths. In this way the drying out behaviour can be monitored and the moisture content status can be determined earlier, saving time and without any further extraction of material.

Moreover use of this method removes the need for additional purchases of the appropriate special sensors, since the conventional moisture content sensor in the Multi-Measure series can be used for the measurements.

If in the materials to be tested the basic properties such as the water/cement ratio, porosity and density are approximately in agreement it is possible to use in the analysis a sorption isotherm that has not been produced especially for the material in question. In the case of concrete in particular it is easy to apply absorption isotherms that are available in the literature.

In the moisture content range between 30 and 80 % r.h. the validity of the measured results using existing sorption isotherms can be seen as sufficiently accurate [15]. Above 80 % no accurate analysis of the building material moisture content can be undertaken because of the more dramatic rise of the sorption isotherms.

The accuracies of the water contents obtained are not comparable with those using the kiln-drying method, but this is also a relative factor because of the advantage of the more rapid on-site assessments that can be made concerning the moisture content status of building components.

As a result of the differing doctrines there exists a greater need for research regarding the use of the hygrometric method, in particular when determining the readiness of screeds to be covered. At this point in time we are of the opinion that the method provides an aid to orientation (dry/moist) under practical conditions, but is not suited to accurate determination of the readiness of screeds to be covered.

However when considered in conjunction with the ambient atmospheric conditions in the room and the building material equilibrium moisture content thereby achieved, it is possible to make **statements concerning the achievability of readiness to be covered that are for the most part adequate.**

From Table 18b one can recognise that at a room air humidity above 70 to 75 %, in the case of anhydrite screeds, or above 40 to 50 %, in the case of cement screeds, the water content levels required to achieve readiness for covering cannot in fact be met.

The relative air humidity values in new builds lie far above these values, because of the ambient atmospheric and spatial conditions, and vary between 80 and 95 %. Thus the air humidity values required cannot be achieved at all without the use of artificial drying measures.

| Building material | Upper floor covering | Limiting value for air humidity |
|----------------------------------|--|---------------------------------|
| Watertight screed/concrete | Coverings/coatings that do not allow diffusion | 75 % r.h. |
| Magnesia screed/anhydrite screed | Coverings/coatings with diffusion resistance (S_d) > 2 m | 65 % r.h. |
| Screed/concrete | Parquet | 55 % r.h. |

Table 18a: Possible limiting value for relative air humidity as a function of building material and the upper floor covering (from Rieche [14])

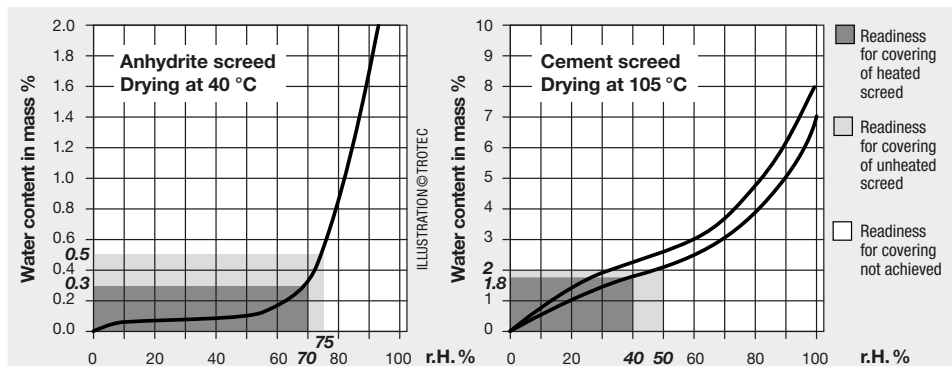

Maximum moisture content of readiness for covering heated/unheated screed*:

| Anhydrite screed | | Floor covering | Cement screed | |
|------------------|--------|---|---------------|--------|
| unheated | heated | | unheated | heated |
| 0.5 % | 0.3 % | Elastic and textile coverings | 2.0 % | 1.8 % |
| 0.5 % | 0.3 % | Parquet and wooden blocks | 2.0 % | 1.8 % |
| 0.5 % | 0.3 % | Laminate floors | 2.0 % | 1.8 % |
| 0.5 % | 0.3 % | Stone and ceramic floors in thick and thin beds | 2.0 % | 1.8 % |

The moisture contents given above are weight percentages that have been determined using the CM method.

* Magnesia screed: 1.0 to 3.5 - according to the composition of the organic components; established values are to be obtained from the manufacturer.

Table 18b: Sorption isotherms of anhydrite screed and cement screed

The method is suitable for the measurement of **variations in moisture content in floor and wall structures**. Here the measured results are independent of the building material in question. Bulk density or lack of homogeneity does not affect the relative, time-related measured results.

4.4.4 Interference effects and instructions to be followed for the hygrometric method

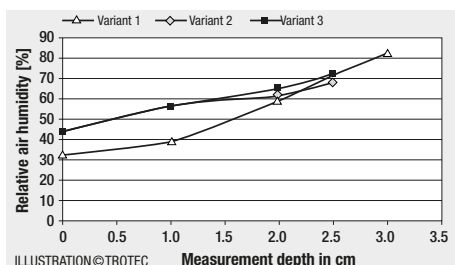

Variant 1: Measurement without sealing sleeve in the drilled hole

Variant 2: Measurement with sealing sleeve in the drilled hole

Variant 3: Measurement at a particular depth with 0.5 cm free height of drilled hole wall in each case

Figure 42: Measurement of the relative air humidity in a drilled hole at different depths and with different variants on samples of Type A. [15]

Sources of errors lie not only in using flawed or incorrect sorption isotherms as points of reference, but also where there is an elevated salt content in the building material. The relative humidity that is attained in the drilled hole alters where there is an elevated salt content. Similarly temperature differences between the building material and the ambient air that are too large lead to misinterpretations [16].

A further source of error results from the failure to use a measurement sleeve. Without a measurement sleeve that is closed on all sides the air humidity in the drilled hole adjusts to that across the whole structure, which, depending on the depth of the drilled hole, can lead to lower air humidity values. This situation occurs particularly in the case of drilled hole depths < 2 cm. With a greater depth the error is smaller (see Figure 42) [15].

4.5 Building material moisture content measurement - microwave method

The microwave method belongs to the category of dielectric moisture content measurement methods. Dielectric measurement methods are based on the dielectric properties of the water. Water is a polar molecule, i.e. the centres of charge within the molecule are not coincident.

For this reason the water molecule in an externally applied field aligns itself in a preferred direction; in other words, it can be polarised. If an alternating electromagnetic field is applied the molecules start to rotate with the frequency of the field (orientation polarisation). At the macroscopic level this effect is identified by the physical quantity of dielectric constant.

The dielectric effect in water is so pronounced that the dielectric constant of water is about 80. The dielectric constant of most solids, including building materials, is significantly smaller; it lies in the range 2 ... 10 and most usually between 3 and 6. What is measured is therefore the difference between the dielectric constant of water and the dielectric constant of the building materials. Because of the large difference between these values it is easy to detect even small quantities of water.



4.5.1 Measurement principle

At increasing frequencies the water molecule is less and less able to follow an externally applied alternating electromagnetic field, on account of the bonding forces internal to the material (the water molecule "swims" in the water and is linked to the other molecules).

A type of friction occurs internal to the material, or, in other words, dielectric losses arise. When a sufficiently high level of power is radiated into the material this leads to a process of heating. This effect is used, e.g. in the domestic microwave, for the heating of food.

With special microwave configurations it is possible to measure the dielectric losses. The levels of radiated power required for this purpose are many orders of magnitude smaller than those necessary for heating purposes; they can be less than 1 mW. In this way any kind of risk to health caused by electromagnetic radiation (electromagnetic pollution) is excluded.

The maximum dielectric losses for water occur at a frequency of around 20 GHz. However the corresponding wavelength of the electromagnetic wave is so small that measurement at this frequency is not practical. Moreover, the dielectric losses are still high enough at lower frequencies to be able to gain evidence of the presence of water.

In the microwave range, in addition to the high dielectric constant of the water (or more accurately, the real part of the dielectric constant) the dielectric losses (or more accurately, the imaginary part of the dielectric constant) can also be used as measurement parameters. They correspond very closely with the physical properties of the water.

In addition the microwave range exhibits a number of other advantages. As can easily be shown from the basic electromagnetic equations, the influence of the resistive losses (ionic conductivities, e.g. caused by presence of salts in the brickwork) reduces strongly at increasing frequencies. From about 1 GHz these losses are virtually negligible compared with the dielectric losses. **Microwave methods are therefore virtually independent of the presence of salts.**

4.5.2 Moisture content measurement with the TS 610 SDI microwave sensor

The TS 610 SDI microwave sensor contains an antennae assembly that **enables non-destructive penetration to depths of up to about 30 cm**.

It is therefore suitable for determining the moisture content throughout the volume of the material being measured (Figure 43). Measurement takes place in accordance with a reflection principle, i.e. it is the moisture-dependent component of the wave that is reflected from the material being measured.

For measurement purposes the measuring head is placed **flat** on as smooth a surface as possible of the material being measured. **In general care must be taken that no metal surfaces are allowed to be located underneath the material being measured.**

The antennae assembly creates an electromagnetic wave from the electromagnetic oscillation generated in the measuring head, and this wave propagates into the material.

Here it is not only the volume elements near the surface that contribute to the reflection of this wave, but also elements that lie at a greater depth. The weighting of the contribution of the individual volume elements reduces with increasing depth. That is to say, deeper lying zones of moisture influence the value displayed proportionately less than moisture penetration near the surface.

In operation the following points are to be noted:

The influence of the surface roughness is not as great because of the high depth of penetration. A measurement taken on materials featuring small scale surface roughness with surface finishes > 10 mm must, however, be considered as critical.

You should also make sure that the sensor does not tilt during the measurement.

Minimum thickness of material

The microwave field penetrates the material being measured by 20 to 30 cm, depending on the material and moisture content. The materials in which moisture is to be measured must therefore exhibit this thickness at least (see Figure 44).

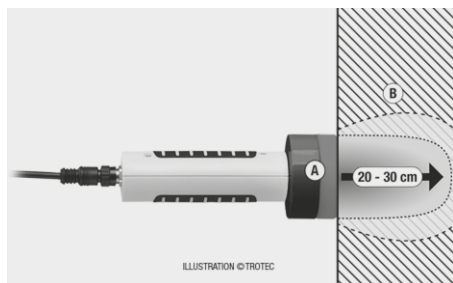

Figure 43: For measurement purposes place the measuring head (A) of the TS 610 SDI microwave sensor at right-angles to the material being measured.

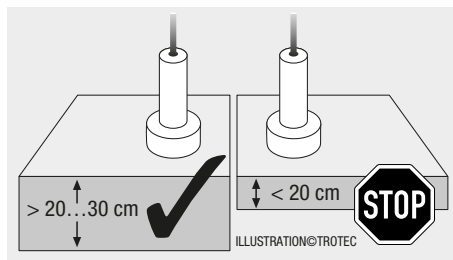

Figure 44: The materials that are to be measured must be at least 20 to 30 cm thick.

If the material being measured – e.g. a wall – has a lower thickness, components of the electromagnetic wave radiated from the TS 610 SDI sensor are reflected from the rear face of the material, and these are superimposed on the moisture-dependent reflections at the measuring head antenna. Depending upon moisture content and material this effect can lead to distortions of the measured value that are sometimes severe. Thus, for example, a high measured value can be displayed when moisture contents are low, or vice versa!

In contradiction to earlier information given we should therefore point out that so-called “placeholders” (e.g. measurement pads made from extruded polystyrene or solid rubber) for use with materials whose thickness is too thin can affect the result adversely and are therefore not recommended!

Instead as dense as possible a grid pattern of measurements (or measurement cluster, see Section 4.5.3) should always be carried out over the whole of the surface that is being tested (see Figures 46, 47). In this way measurement

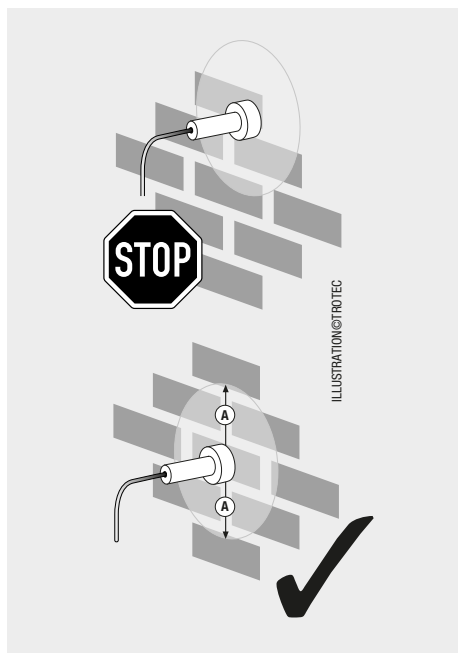

Figure 45: The minimum distance to the edge of the material being measured (A) must be at least 10 cm.

errors caused by varying material thickness or lack of homogeneity can be minimised. It is recommended that a sketch should be prepared for the surface that is being tested, in which the measured values can be entered. Later these can, e.g. using a spreadsheet program, be displayed as a coloured distribution of moisture content (see Section 4.5.4).

Minimum distance from lateral boundaries

The microwave field of the TS 610 SDI sensor exhibits a pronounced lateral spread (Figure 43). A minimum distance of 10 cm must therefore be maintained from the lateral boundaries of the material being measured; otherwise the values measured may be distorted.

The measurement volume can be seen, roughly simplified, as a cylinder with a radius of 10 ... 15 cm. The minimum lateral distance to the boundary of the material being measured is therefore prescribed as 10 cm (Figure 45).

A measurement of moisture content with a lesser distance to the lateral edge of the material being measured can lead to a distortion of the value measured.

For meaningful and accurate measurement with the TS 610 SDI microwave sensor you must therefore always ensure that the measurement volume considered is sufficiently large.

Measurement procedure

If the moisture distribution in mineral building materials is to be determined, basically the following work steps must be performed:

1. Connect the TS 610 SDI sensor with the TC 30 SDI connection cable to the measurement device .
2. Switch on the device.
3. Setting measurement method in the T3000.
4. Hold the sensor up in the air after switching on to check its functionality. Keep a minimum distance of 50 cm away from solid materials. The value in the display must be set to zero; otherwise the sensor is not properly calibrated (see operating instructions, Section 6.8).
5. Press the sensor head hard down onto the surface of the material and align the shaft at right-angles to the surface.
6. In the display the current measured value is shown in the display field of sensor 1 without a unit. For a better understanding this display value is to be understood as a digit (digital numerical value).

Before taking measurements any contaminants must be removed from the surface of the mineral building material (e.g. paint residues, dust).

4.4.4 Interference effects and instructions to be followed for the microwave method

The measured values are to be interpreted as relative values, since by means of the method of measurement described above it is purely a difference between dry and moist building materials that can be discerned.

This is based on the fact that the bulk density of the building material has an immediate effect on the dielectric constant.

Comparison measurements are carried out on similar materials by firstly measuring on an evidently dry wall or floor surface; the value obtained forms the dry reference value.

The main use lies in comparative measurements on the same building material or similar components. According to the value displayed moisture zones can be determined and demarcated.

In principle isolated measurements should not be carried out, but rather comparative measurements should always be performed over a grid pattern. For this purpose a grid is to be laid on to the surface to be measured and a measurement value is to be determined for each individual square of the grid (see Section 4.5.4).

Measurements using the microwave method are also suitable for surveys of water damage and for location of leakages.

If metal is contained in the test piece (e.g. pipes, electrical circuits, reinforcement, plaster supports), the value measured rises dramatically. Because of its effectiveness at depth the sensor is also suitable for the location of metallic items and for the location of metal reinforcement.

Because of the relationship described above, between the material bulk density and the dielectric constant for building materials, varying values can be displayed where there are multi-layer structures or different material densities within the floor and wall regions. In order to minimise any errors of interpretation that may result, **a cluster of measurements should be taken.**

Here within a radius of 20 cm at least five different depth measurements are taken and from these individual results the average value is formed. This value then forms the value for comparison with other cluster measurement locations.

Where the materials are homogeneous (e.g. brickwork thicker than 30 cm) it is not absolutely essential to undertake a cluster of measurements. For more accurate analysis, however, a cluster of measurements is also recommended in this case. Here three measurements within a radius of 15 cm are in general sufficient as a basis for assessment.

4.5.4 *Combined use of the TS 660 SDI and TS 610 SDI in building diagnostics*

The combined use of the TS 660 SDI measurement sensor for surface moisture content and the TS 610 SDI measurement sensor for moisture content at depth has proved itself in practice in the non-destructive diagnosis of occurrences of damp.

In particular for the topics of:

- **causal analysis of mould growth due to condensation humidity in domestic property**
- **rising damp in brickwork or stonework**
- **hygroscopic occurrences of damp caused by the presence of salts**
- **location of failures in sealing systems and leakages**

combined use of the sensors allows complex sets of conditions to be characterised, demarcated and classified.

The central feature of this method lies in the option of being able to measure moisture content at various depths. The TS 660 SDI sensor registers the upper 2 to 4 cm of the building material. With the TS 610 SDI depth sensor the volume-related values of water content can be measured up to a depth of 30 cm. High moisture content values in regions near the surface down to 1 cm are hardly registered by this sensor.

If both measurement methods are now used in a combined manner, preferably by means of grid measurements, one can draw valid conclusions regarding the multi-dimensional distribution of moisture content.

For optimal evaluation of the measured values, the analysis software MultiMeasure Studio is recommended, specifically developed by Trotec:

1. STD: <http://hub.trotec.com/?id=24125>

2. PRO: <http://hub.trotec.com/?id=24126>

After conversion of the numbers into graphical format it is possible to obtain visually discernable distributions of both surface moisture content and also the moisture content at various depths (see Figures 46 to 48).

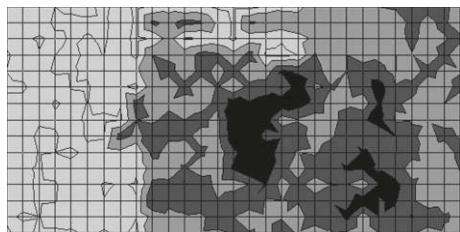

Figure 46a: Moisture content distribution on the surface

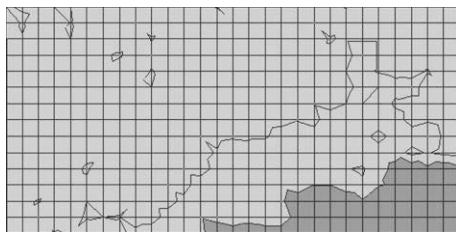

Figure 47a: The surface measurements show lower moisture content values

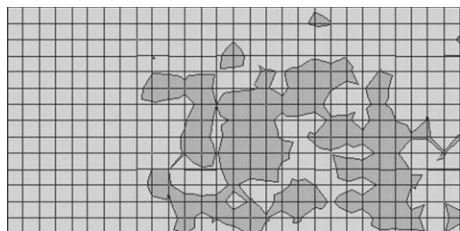

Figure 46b: Moisture content distribution at depth

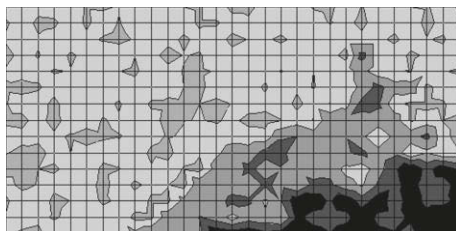

Figure 47b: The measurements at depth show higher moisture content values

4.5.4.1 Causal analysis of mould growth as a result of condensation moisture

The problems associated with formation of condensation moisture in domestic property can be simply and reliably diagnosed with the combined use of the TS 660 SDI and TS 610 SDI sensors. Condensation moisture manifests itself in many cases as an increased moisture content in regions near the surface, while layers deeper inside the brickwork remain dry.

An example of how such facts can be visually presented can be seen in Figure 46. If now, by means of measurements of conditions in the room (relative humidity, room temperature and dew point temperature), it can also be verified that the temperature and air quality conditions in the affected areas confirm the results of the measurements, e.g., in the wall region, the cause (defective ventilation) can clearly be verified.

Practical tip:

Trotec data loggers have proved effective for long-term measurement of air temperature and relative humidity values

The causes are mostly to do with poor circulation of air in conjunction with low room temperatures as a result of insufficient heating.

However, if the measurements at depth using the TS 610 SDI also indicate increased moisture content values, other causes for the damage caused by damp (e.g. leaking risers, gutters or drains etc.) may also be present.

4.5.4.2 Rising damp in the brickwork and stonework / hygroscopic occurrences of damp caused by the presence of salts

Rising damp can also be diagnosed with the combined use of both sensors.

From the grid pattern measurements it can be seen from the moisture content profile in Figure 47 that rising damp is present in the brickwork or stonework: The moisture content measurements at depth (47b) in the brickwork have yielded significantly higher values than the surface moisture measurements (47a).

Hygroscopic occurrences of damp

In the case of hygroscopic occurrences of damp caused by the presence of salts other measurement results can sometimes occur according to cause. However, because of the independence of the microwave method from the

effects of the presence of salts these problems can also be analysed.

After the evaporation of the moisture out of the brickwork the salts remain on the surface. When combined with an increased air humidity in the room this leads once again to a renewed enhancement of the moisture content.

This hygroscopic dampness is represented in a manner that is exactly the reverse of that shown in the measurement results in figure 47. While now the highest measured values are those measured with the surface sensor, the values measured at depth are significantly lower.

Hygroscopic dampness can reliably be distinguished from condensation moisture content by analysis of the parameters describing atmospheric conditions (temperature, relative humidity, dew point, etc.).

4.5.4.3 Location of failures in sealing systems and leakages

For the location of failures in sealing systems and leakages a start is made with measurements at various depths. Here also the use of measurements over a grid pattern is to be recommended for a better representation of the results and for the avoidance of misleading conclusions.

In this connection it is important that the measurements at depth are always carried out as relative measurements that are compared with a dry surface on the same component or building material.

Individual "outliers" amongst the measured values should not be taken into account since these can also be caused by metallic objects or lack of homogeneity in the material structure. If this point is not observed the risk of misleading interpretations is large.

If no tabular or graphical evaluations are undertaken, a cluster of measurements must be performed to locate failures in the sealing of multi-layer structures (floating screeds, partition walls, etc.).

Here within a radius of 20 cm measurements are taken at a minimum of 5 different depths and from these individual results the average value is formed. This value then forms the value for comparison with other cluster measurement locations.

Where the materials are homogeneous (e.g. brickwork thicker than 30 cm) it is not absolutely essential to undertake a cluster of measurements.

For more accurate analysis, however, a cluster of measurements is also recommended in this case. Here three measurements within a radius of 15 cm are in general sufficient as a basis for assessment.

The causes of damage and damage locations can be recognised in zones with severely raised moisture content values (Figure 48).

By means of follow-up measurements with the surface moisture content sensor it can now also be determined as to whether the screed or the upper covering has also been affected.

By adherence to the above listed factors failures in sealing systems and leakages can be determined according to the type and extent of damage.

However at this point it must be stressed that the search for leakages in pipework systems in particular usually requires a complex set of measuring instruments, and that the damage locations can often not be pinpointed using the moisture content measurement method on its own.

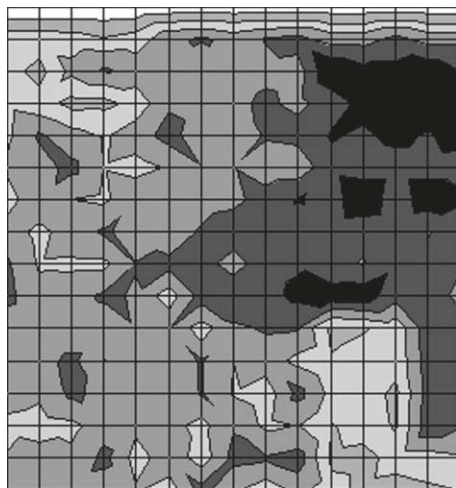

Figure 48: Darker areas in the measurement image identify severely raised moisture content values.

5. Measurement of airflow velocity



In the hot film anemometer (HFA) an electrical resistance is heated to a defined temperature. A flow of air cools the resistance until an equilibrium is attained between the heat that is transferred to and from the film.

The higher the velocity of the airflow, the greater is the transfer of heat from the film. The influence of the ambient temperature is compensated for in the electrical circuitry.

TS 410 SDI measurement principle

The TS 410 SDI sensor is a constant temperature anemometer (CTA). In this type of device the electrical resistance is supplied with power such that the temperature of the resistance remains constant.

Here the power required is a measure for the airflow velocity. Using this method it is possible to achieve higher sensitivities.

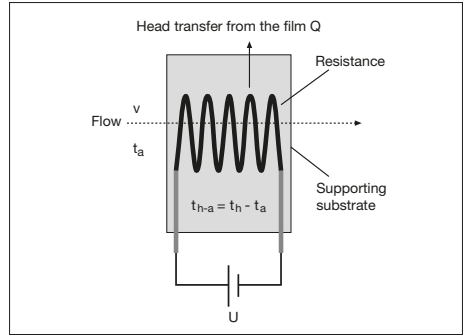

Influence of orientation dependency

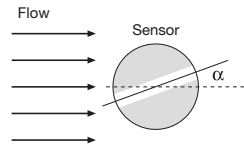

The correct orientation of the sensor head to the flow significantly affects the accuracy of the measurement.

In this respect the TS 410 SDI has a relatively weak dependence on angle. To a first approximation the measurement error E can be described as a function of the angle of incidence α by means of the equation:

$$E [\%] = \alpha / 5 \quad (0 < \alpha < 25^\circ)$$

Example: An angle of incidence of 25° produces a measurement error of approx. $25 / 5 = 5 \%$

| h / [m] | 0 | 50 | 100 | 200 | 300 | 500 | 800 | 1,000 | 1,500 | 2,000 | 3,000 | 4,000 | 5,000 |
|-------------------|----------|----------|----------|--------|--------|-------|--------|--------|--------|--------|--------|--------|--------|
| p [hPa = mbar] | 1,013.25 | 1,006.94 | 1,000.67 | 988.25 | 975.98 | 951.9 | 916.88 | 894.26 | 840.11 | 789.24 | 696.56 | 614.76 | 542.57 |
| Correction factor | 1.000 | 1.006 | 1.013 | 1.025 | 1.038 | 1.064 | 1.105 | 1.133 | 1.206 | 1.284 | 1.455 | 1.648 | 1.868 |

Table 19: Correction factor as a function of the location height

Influence of the air pressure

The measurement of the flow velocity with a thermal anemometer is dependent on the air pressure p that is present. In the factory the sensor is calibrated to a standard pressure $p_0 = 1013.25$ mbar. For a velocity measurement at the height above sea level h the measured value must be corrected using the barometric height

formula. In practice for this purpose one needs only to multiply the velocity value v_T measured with the sensor by a correction factor for the height h in question (from Table 19). The correction factor is the quotient of the average air pressure (1013.25 hPa) and the actual air pressure referred to sea level.

6. Calibration service

You have the option of allowing us to calibrate your measurement device and can contact us in the event of problems.

Calibration is only seldom necessary. However, if stringent requirements are placed on the precision of the values measured, the sensors should be calibrated on an annual cycle.

You can perform single-point calibrations yourself, but we advise against doing so because professional reference values are not usually available.

Professional calibrations are available from a certified German Calibration Service (GCS) location. There the sensors

undergo a single-point and/or multi-point calibration in accordance with GCS or ISO requirements. The difference between GCS and ISO calibration is that in calibration according to GCS directives each test point must be performed twice, whereas for ISO only once.

The GCS certificate offers the following advantages:

- International validity
- Authoritative also in court
- Regular monitoring of the calibration laboratory
- Calibration in accordance with prescribed directives

There follows a table in which the measured quantities or calibration items are listed.

| Measured quantity or calibration item | Measurement range | Measurement conditions | Measurement accuracy | Comments |
|---|------------------------|---|----------------------|---|
| Temperature | | | | |
| Resistance thermometers | 0.01 °C | Water triple point | 10 mK | Calibration at fixed temperature points |
| | 0.0 °C | Ice point | 15 mK | |
| Resistance thermometers, direct display thermometers, mechanical thermometers | -40 °C to 200 °C | Stirred fluid baths | 30 mK | Comparison with reference thermometers in thermostatically controlled baths U_{TH} is the uncertainty contribution from the calibration item |
| Thermocouples | -40 °C to 200 °C | | 0.2 K | |
| Electrical thermometers with evaluation electronics attached | -40 °C to 200 °C | | $U_{TH} + 0.05$ K | |
| Resistance thermometer, direct display thermometer, mechanical thermometer | -40 °C to 100 °C | Climatic test cabinet | 0.1 K | Comparison with reference dew point chilled mirror in climatic test cabinet U_{TH} is the uncertainty contribution from the calibration item |
| Thermohygrographs | -40 °C to 100 °C | | 0.5 K | |
| Electrical thermometers with evaluation electronics attached | -40 °C to 100 °C | | $U_{TH} + 0.05$ K | |
| Dew point temperature | | | | |
| Hygrometer with direct recording of temperature | -18 °C to 25 °C | Climatic test cabinet | 0.1 K | Comparison with reference dew point chilled mirror in climatic test cabinet |
| Relative humidity | | | | |
| Hygrometer with direct recording of relative humidity | 5 to 30 % | Climatic test cabinet air temperature 5 °C to 95 °C | 0.4 % | Comparison with reference dew point chilled mirror in climatic test cabinet |
| | 30 to 60 % | | 0.6 % | |
| | 60 to 95 % | | 0.8 % | |
| Thermohygrographs | 5 to 95 % | Climatic test cabinet air temperature 5 °C to 60 °C | 1.5 % | |
| Absolute pressure | | | | |
| Mechanical and electronic barometers | 700 mbar to 1,200 mbar | Pressure medium: gas | 0.15 mbar | Comparison with precision pressure measurement system |

7. Summary

The general data, definitions of terms, tables and permissible limits contained in the practice handbook have been taken from the specialist literature. The manufacturer of the equipment does not provide any guarantee as to correctness. Any conclusions drawn from the results measured remain the responsibility of the user, since each measurement is dependent upon local conditions. In addition the recognised technological regulations alter in the course of time; knowledge of these remains the responsibility of the user.

8. References

- [1] Kupfer, K.: Materialfeuchtemessungen: Grundlagen, Messverfahren, Applikationen, Normen; [Material moisture content measurements: principles, measurement methods, applications, standards] Expert-Verlag; Renningen-Malmshelm 1997
- [2] Weiß, S.; Ungerer, K.: Feuchtemessverfahren bei Gebäudeschäden; [Methods for measurement of moisture content in damage to buildings] Lauth & Partner GmbH; Waiblingen 1995
- [3] Lohmann, U.: Holz-Handbuch, 5. Auflage; [Wood manual, 5th edition] DRW-Verlag; Rosenheim 1998
- [4] Kühnen, R.; Wagenführ, R.: Werkstoffkunde Holz für Restauratoren; [Wood materials science for restorers] Seemann-Verlag; Leipzig 2002
- [5] Lutz, Jenisch, Klopfer, Freymuth, Krampf, Petzold: Lehrbuch der Bauphysik – Schall-Wärme-Feuchte-Licht-Brand-Klima, 5. Auflage; [Textbook of building physics – sound-heat-moisture-light-fire-climatic conditions, 5th edition] Teubner-Verlag; Stuttgart/Leipzig/Wiesbaden 2002
- [6] Schneider, K.-J.: Bautabellen für Ingenieure mit europäischen und nationalen Vorschriften, 12. Auflage; [Building tables for engineers with European and national regulations, 12th edition] Werner-Verlag; Düsseldorf 199
- [7] Frey, Herrmann, Krausewitz, Kuhn, Lillich, Nestle, Nutsch, Schulz, Traub, Waibel, Werner: Bautechnik – Fachkunde Bau, 10. Auflage; [Building technology - Building core studies, 10th edition] Verlag Europa-Lehrmittel; Haan-Gruiten 2003
- [8] Fischer, H.: Schadensanalyse und bauphysikalisches Messen – Einführung in die elektrische Messtechnik von Feuchte – Temperatur – Schall; [Analysis of damage and building physics measurements – Introduction to electrical measurement technology for moisture – temperature – sound] Expert-Verlag; Ehningen 1993
- [9] William L. James: Electric moisture meters for wood. Gen. Tech. Rep. FPL-GTR-6. Madison, WI; U.S. Department of Agriculture, Forest Service, Forest Products Laboratory; 1988
- [10] Simpson, William T.: Resistance moisture meter correction factors for four tropical wood species Res. Note FPL-RN-0260. Madison, WI; U.S. Department of Agriculture, Forest Service, Forest Products Laboratory; 1994
- [11] Cziesielski E.: Bauphysik-Kalender; [Building physics annual review] Verlag Ernst & Sohn; Berlin 2004
- [12] Kohl A., Bastian, Neizel: Baufachkunde Teil 1 – Grundlagen, 17. Auflage; [Building core studies, Part one - Fundamentals, 17th edition] Teubner-Verlag; 1981
- [13] Kober A.; Plinke B.: Feuchtemessung an Holz, Holzwerkstoffen und Baustoffen – Eine Literaturübersicht; [Moisture content measurements in wood, wood-based materials and other building materials – an overview of the literature] Fraunhofer-Arbeitsgruppe für Holzforschung Wilhelm-Klauditz-Institut (WKI); WKI-Bericht Nr. 21; Braunschweig 1989
- [14] Rieche, G.: Neue Wege der Feuchtemessung und Beurteilung von Estrichen und Betonen; Beton- und [New methods for measurement of moisture content and assessment of screeds and concretes] Stahlbetonbau 99 (2004) Heft 10; Ernst & Sohn Verlag; Berlin 2004
- [15] Bluhm, Stefanie: Entwicklung und Untersuchung einer Methode für die hygrometrische Bestimmung der Feuchte in Zementestrichen; [Development and investigation of a method for the hygrometric determination of moisture content in cement screeds] Diplomarbeit im Studiengang Bauphysik; Fachhochschule Stuttgart; 2002
- [16] Rieche, G.: Sachstandsbericht zur Messung der Feuchte von mineralischen Baustoffen (State of the art Report); [State-of-the-art report for measurement of moisture content in mineral building materials] Schriftenreihe Heft 74; 2002
- [17] ASTM International: Standard Test Method for Determining Relative Humidity in Concrete Floor Slabs Using in situ Probes; Designation F 2170-02; 2004
- [18] Raupach, M.; Dauberschmidt, C.; Harnisch, G.: Bestimmung des Wassergehaltes ausgewählter Baustoffe mit Hilfe von Widerstands- bzw. kapazitiven Messungen; [Determination of the water content in selected building materials with the aid of resistance and capacitive measurements] IBAC Institut für Bauforschung, Aachen 2004
- [19] Zimmermann, G.; Jenisch, R.: Schadensfreies Bauen, Tauwasserschäden, Band 16, [Building without damage, Condensation damage, Volume 16] Fraunhofer IRB-Verlag, Stuttgart 1996

Trotec GmbH & Co. KG

Grebbeener Str. 7
D-52525 Heinsberg

 +49 2452 962-400

 +49 2452 962-200

info@trotec.com

www.trotec.com